

Service Manual

74 PMD320/02B, U

74 PMD321/02B, U

Compact disc Player

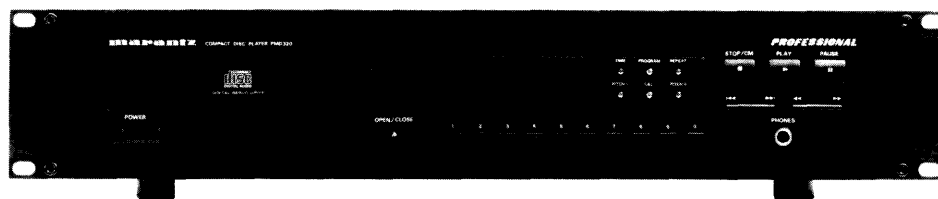

COMPACT
disc
DIGITAL AUDIO

TABLE OF CONTENTS

SECTION	PAGE
1. TECHNICAL SPECIFICATIONS	1
2. CAUTION	2
3. NOTES ON BALANCED OUTPUTS CONNECTORS	3
4. SERVICE MODE	3
5. MICROPROCESSOR AND IC DATA	4
6. SERVICING HINTS (Pitch Control)	7
7. WAVE FORM	9
8. BLOCK DIAGRAM	11
9. SCHEMATIC DIAGRAMS AND PARTS LOCATION (PATTERN SIDE)	13
10. EXPLODED VIEW AND PARTS LIST	21
11. ELECTRICAL PARTS LIST	24

Please use this service manual with referring to the user guide (D.F.U.) without fail.

marantz®

model PMD320 / PMD321

First issue : 1995/6

313K855010

MARANTZ DESIGN AND SERVICE

Using superior design and selected high grade components, **MARANTZ** company has created the ultimate in stereo sound. Only original **MARANTZ** parts can insure that your **MARANTZ** product will continue to perform to the specifications for which it is famous.

Parts for your **MARANTZ** equipment are generally available to our National Marantz Subsidiary or Agent.

ORDERING PARTS:

Parts can be ordered either by mail or by Fax.. In both cases, the correct part number has to be specified.

The following information must be supplied to eliminate delays in processing your order:

1. Complete address
2. Complete part numbers and quantities required
3. Description of parts
4. Model number for which part is required
5. Way of shipment
6. Signature: any order form or Fax. must be signed, otherwise such part order will be considered as null and void.

USA

MARANTZ AMERICA, INC.
440 MEDINAH ROAD
ROSELLE, ILLINOIS 60172 - 2330
USA
PHONE : 708 - 307 - 3100
FAX : 708 - 307 - 2687

CANADA

LENBROOK INDUSTRIES LIMITED
633 GRANITE COURT,
PICKERING, ONTARIO L1W 3K1
CANADA
PHONE : 416 - 831 - 6333
FAX : 416 - 831 - 6936

EUROPE

MARANTZ EUROPE B.V.
P.O.BOX 80002
BUILDING SFF2
5600 JB EINDHOVEN
THE NETHERLANDS
PHONE : +31 - 40 - 732241
FAX : +31 - 40 - 735578

PROFESSIONAL USA

SUPERSCOPE TECHNOLOGIES, INC.
MARANTZ PROFESSIONAL PRODUCTS
1000 CORPORATE BLVD., SUITE D
AURORA, ILLINOIS 60504 USA
PHONE : 708 - 820 - 4800
FAX : 708 - 820 - 8103

PROFESSIONAL CANADA

TC ELECTRONICS CANADA LTD
540 FIRING AVE.
BAIE D'URFÉ, QUEBEC H9X 3T2
CANADA
PHONE : 514 - 457 - 4044
FAX : 514 - 457 - 5524

TRADING

MARANTZ EUROPE B.V.
P.O.BOX 80002
BUILDING SFF2
5600 JB EINDHOVEN
THE NETHERLANDS
PHONE : +31 - 40 - 732241
FAX : +31 - 40 - 735578

AUSTRALIA

MARANTZ AUSTRALIA
3 Figtree Drive
Australia Centre
Homebush, NSW2140 AUSTRALIA
PHONE : +61 2 742.8311
FAX : +61 2 7643074

HONG-KONG

FORWARD INTERNATIONAL CORP. LTD.
15 TH FLOOR, REGENT CENTRE,
88 QUEEN'S ROAD, CENTRAL, H. K.
PHONE : +852 521 - 0883
FAX : +852 521 - 7835

THAILAND

MRZ STANDARD CO., LTD.
746 - 750 WANGBURAPA BANGKOK
10200 THAILAND
PHONE : +66 2222 9181
FAX : +66 2225 8871

TAIWAN

PAI - YUING CO., LTD.
6 TH FL NO. 148 SUNG KIANG RORD,
TAIPEI, 10429, TAIWAN R.O.C.
PHONE : +886 (2) 5221304-8
FAX : +886 (2) 5630415

MALAYSIA

WO KEE HONG ELECTRONICS SDN. BHD.
NO. 102 JALAN SS 21/35, DAMANSARA
UTAMA, 47400 PETALING JAYA
SELANGOR DARUL EHSAN,
MALAYSIA
PHONE : +60 3 - 7184666
FAX : +60 3 - 7173828

SINGAPORE

WO KEE HONG (SINGAPORE) PTE. LTD.
29, LENG KEE ROAD
SINGAPORE 0315,
PHONE : +65 475 - 4555
FAX : +65 475 - 8623

JAPAN—Technical—

MARANTZ JAPN INC.
35 - 1, 7 - chome, Sagamiono
Sagamihara - shi, Kanagawa
Japan
PHONE : +81 427 48 2181
FAX : +81 427 48 0889

JAPAN—Parts Order—

MARANTZ JAPN INC.
35 - 1, 7 - chome, Sagamiono
Sagamihara - shi, Kanagawa
Japan
PHONE : +81 427 48 1013
FAX : +81 427 48 9190

日本マランツ株式会社

本社 〒228 神奈川県相模原市相模大野7丁目35番1号
営業本部 〒150 東京都渋谷区恵比寿南1丁目11番9号

SHOCK, FIRE HAZARD SERVICE TEST:

CAUTION: After servicing this appliance and prior to returning to customer, measure the resistance between either primary AC cord connector pins (with unit NOT connected to AC mains and its Power switch ON), and the face or Front Panel of product and controls and chassis bottom.

Any resistance measurement less than 1 Megohms should cause unit to be repaired or corrected before AC power is applied, and verified before it is return to the user/customer.

Ref. UL Standard NO.1492.

In case of difficulties, do not hesitate to contact the Technical Department at above mentioned address.

1. TECHNICAL SPECIFICATIONS (DIN)

Model PMD320

Audio Characteristics

Channels	2 channels
Sampling frequency	44.1 kHz
Quantization	16-bit linear/channel
Error correction	Cross-interleave read solomon code (CIRC)
D/A conversion	1-bit linear/channel
Wow & flutter	Precision of quartz (Below measurable limits)

Optical Readout System

Laser	GaALAs semiconductor
Wavelength	780 nm

Frequency Characteristics

Frequency range	5 – 20 kHz
Dynamic range	> 96 dB
S/N ratio	> 104 dB
Channel separation (1 kHz)	> 96 dB
THD (1 kHz)	0.004 %
Analogue output jack	
Output level	2V RMS
Output impedance	200 ohms
Digital output	
Pin jack (IEC958-II)	0.5 Vp-p/75 ohms

Power Supply

Power requirements [/02]	230V AC 50 Hz
[U]	120V AC 60 Hz
Power consumption	13 W

Cabinet, etc.

Dimension (Max)	
Width	19 inches (482.6 mm)
Height	4-1/16 inches (103.1 mm)
Depth	12-1/4 inches (312.0 mm)
Net weight	3.9 kg

Operating temperatures	+5 °C ~ +35 °C
Operating humidity	5 % ~ 90 % (without dew)

Accessories

Stereo audio cable with RCA pins	1 set
--	-------

Model PMD321

Audio Characteristics

Channels	2 channels
Sampling frequency	44.1 kHz
Quantization	16-bit linear/channel
Error correction	Cross-interleave read solomon code (CIRC)
D/A conversion	1-bit linear/channel
Wow & flutter	Precision of quartz (Below measurable limits)

Optical Readout System

Laser	GaALAs semiconductor
Wavelength	780 nm

Frequency Characteristics

Frequency range	5 – 20 kHz
Dynamic range	> 96 dB
S/N ratio	> 104 dB
Channel separation (1 kHz)	> 96 dB
THD (1 kHz)	0.004 %
Analogue output jack (XLR)	
Output level	1.2V RMS at -15 dB unloaded
Output impedance	100 ohms
Digital output	
Pin jack (IEC958-II)	0.5 Vp-p/75 ohms
XLR jack (IEC958-II)	3.5 Vp-p/110 ohms

Power Supply

Power requirements [/02]	230V AC 50 Hz
[U]	120V AC 60 Hz
Power consumption	13 W

Cabinet, etc.

Dimension (Max)	
Width	19 inches (482.6 mm)
Height	4-1/16 inches (103.1 mm)
Depth	12-1/4 inches (312.0 mm)
Net weight	3.9 kg

Operating temperatures	+5 °C ~ +35 °C
Operating humidity	5 % ~ 90 % (without dew)

Specifications subject to change without prior notice.

2. CAUTION

LASER NOTE:
DANGER — Invisible laser radiation when open. AVOID DIRECT EXPOSURE TO BEAM.
CAUTION — Use of controls or adjustments or performance of procedures other than those specified herein may result in hazardous radiation exposure.
CAUTION — The use of optical instruments with this product will increase eye hazard.

THE COMPACT DISC PLAYER SHOULD NOT BE ADJUSTED OR REPAIRED BY ANYONE EXCEPT PROPELY QUALIFIED SERVICE PERSONNEL.

LASER BEAM RADIATION SPOT

Laser Diode Properties

Material: Al GaAs

Wavelength: 780nm ± 20nm

Laser Output: Continuous Wave max. 0.5mW

Safety regulations require that the set be restored to its original condition and that parts which are identical with those specified be used.

ESD



All ICs and many other semi-conductors are susceptible to electrostatic discharges (ESD).

Careless handling during repair can reduce life drastically.

When repairing, make sure that you are connected with the same potential as the mass of the set via a wrist wrap with resistance.

Keep components and tools also at this potential.

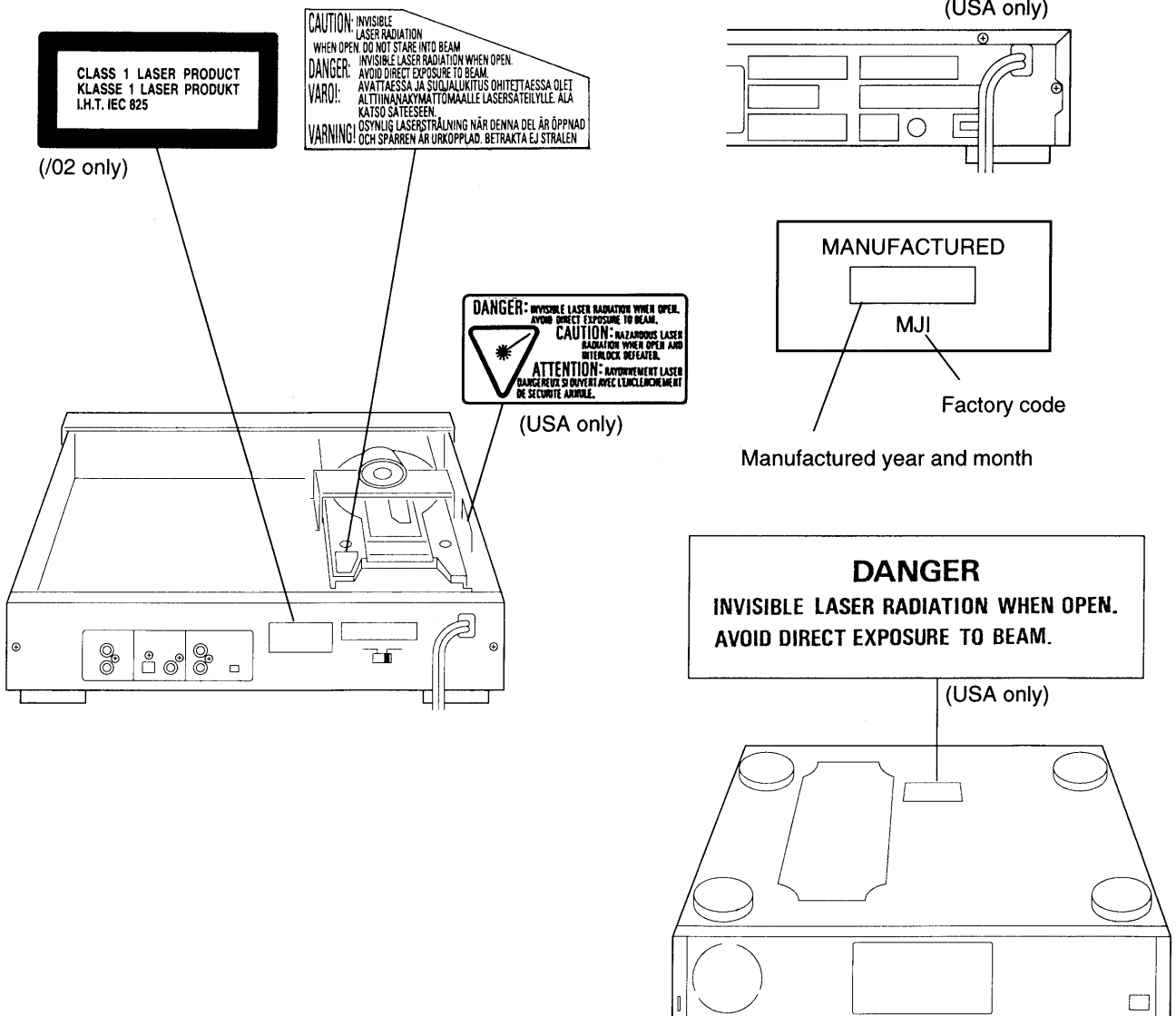

3. NOTES ON BALANCED OUTPUTS CONNECTORS (PMD321 only)

The BALANCED output connectors uses XLR connectors.

There are two types professional-type internal wiring methods for XLR connectors.

1. USA method (Pin 2=COLD, Pin 3=HOT)

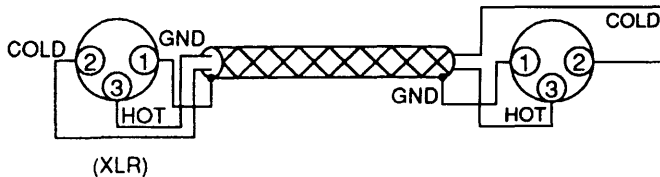

2. Europe method (Pin 2=HOT, Pin 3=COLD)

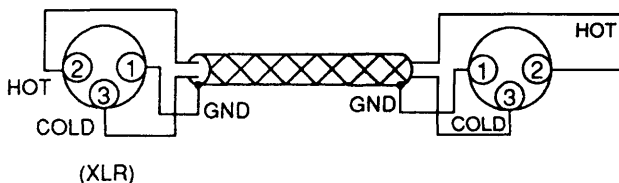

The models use the Europe method described in 2 above.

When XLR connector cables are used and if your preamplifier or main amplifier uses the USA method, the reproduced signal may be out of phase.

In this case, change the connections of pin 2 and pin 3 of one of the XLR connectors of the cable to the Europe method. Also when you use an XLR balanced cable (see illustration below) and if the preamplifier or main amplifier uses the Europe method, change the connections of pin 2 and pin 3 of one of the XLR connectors of the cable to the Europe method.

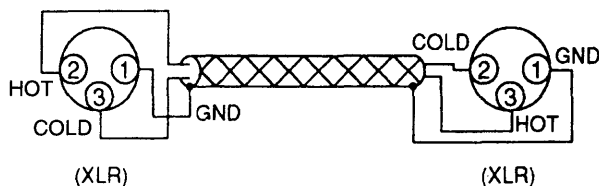

Now the signal can be reproduced in proper phase.

4. SERVICE MODE

1. How to enter into the Service Mode
 - Turn the power on while pressing at least 2 of [STOP/CUE], [PLAY], [NEXT], [PREV] keys.
2. Mode 0 (Display P 00)
 - Condition: [FOCUS OFF] [SPINDLE OFF] [RADIAL OFF] [MUTE ON]
 - The sled moves outside when pressing [FF] or [REW] keys.
 - The function moves to Mode 1 when pressing [NEXT] key.
3. Mode 1 (Display P 01)
 - Condition: [FOCUS ON] [SPINDLE OFF] [RADIAL OFF] [MUTE ON]
 - The function moves to Mode 2 when pressing [NEXT] key.
 - The function moves to Mode 0 when pressing [PREV] key.
4. Mode 2 (Display P 02)
 - Condition: [FOCUS ON] [SPINDLE ON] [RADIAL OFF] [MUTE ON]
 - The function moves to Mode 3 when pressing [NEXT] key.
 - The function moves to Mode 0 when pressing [PREV] key.
5. Mode 3 (Display P 03)
 - Condition: [FOCUS ON] [SPINDLE ON] [RADIAL ON] [MUTE OFF]
 - The Sled moves outside when pressing [FF] key.
 - The Sled moves inside when pressing [REW] key.
 - The function moves to Mode 2 when pressing [PREV] key.

* The following key operation can be available at all of the conditions of the service mode.

- 1) All of FL display light by pressing [STOP/CUE] key.
- 2) Model Number and Version Nbr of the μ -processor are displayed by pressing [PAUSE] key.

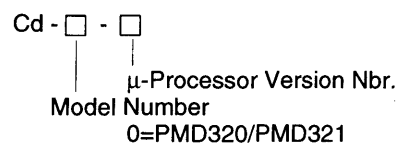

- 3) The same as Normal operation (except Service mode) is performed by pressing [PLAY] key. However if some default is detected, an error code is displayed. (For example: Err 10) The content for each error code is shown below.

Error Code	Error
Err 02	FOCUS Error
Err 07	SUB CODE Error
Err 08	T. O. C Error
Err 09	DECODER Error
Err 10	RADIAL Error
Err 11, 12	SLED Error
Err 13	SPINDLE Error
Err 16 ~ 20	SEARCH Error
Err 30	DOOR Error
Err 31	TRAY Error
Err 32 ~ 47	KEY INPUT Error

6. Cancelling the Service Mode

- The Service Mode is cancelled by turning the power off.

5. MICROPROCESSOR AND IC DATA MN187164 (MICROPROCESSOR)

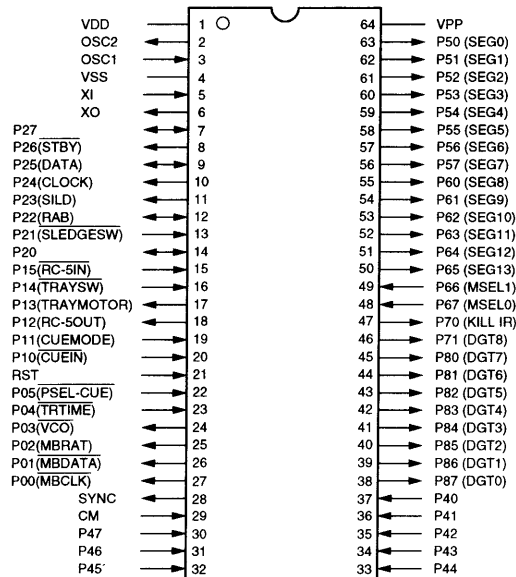

Pin Nbr	Pin Name	I/O	Function	Pin Nbr	Pin Name	I/O	Function
1	Vdd	-	Power Supply +5V	33	P44	I	Key Input, KEY 5
2	OSC2	O	Clock out (8.0MHz)	34	P43	I	Key Input, KEY 4
3	OSC1	I	Clock in (8.0MHz)	35	P42	I	Key Input, KEY 3
4	Vss	-	GND 0V	36	P41	I	Key Input, KEY 2
5	XI	I	0V	37	P40	I	Key Input, KEY 1
6	XO	O	Not Used	38	P87 (DGT0)	O	FL Digit Data, G9
7	P27	I/O	Not Used	39	P86 (DGT1)	O	FL Digit Data, G8
8	P26 STBY	O	TDA1301 RESET, NRST	40	P85 (DGT2)	O	FL Digit Data, G7
9	P25 DATA	I/O	Data Bus Data, SIDA	41	P84 (DGT3)	O	FL Digit Data, G6
10	P24 CLOCK	O	Data Bus Clock, SICK	42	P83 (DGT4)	O	FL Digit Data, G5
11	P23 SILD	O	TDA1301 SILD (latch)	43	P82 (DGT5)	O	FL Digit Data, G4
12	P22 RAB	I/O	SAA7345 RAB	44	P81 (DGT6)	O	FL Digit Data, G3
13	P21 SLEDGESW	I	Sledge SW, SLSW	45	P80 (DGT7)	O	FL Digit Data, G2
14	P20 MUTE	I/O	Not Used	46	P71 (DGT8)	O	FL Digit Data, G1
15	P15 RC5IN	I	RC-5 code Input	47	P70 KILL IR	O	Kill IR, N.C.
16	P14 TRAYSW	I	Tray In/Out SW, TRSW	48	P67 MSEL0	I	Model Select SW 0
17	P13 TRAYMOTOR	O	Tray Motor	49	P66 MSEL1	I	Model Select SW 1
18	P12 RC5OUT	O	RC-5 code Output	50	P65 (SEG13)	O	FL Segment Data, P1
19	P11 CUEMODE	I	CUE Mode Select	51	P64 (SEG12)	O	FL Segment Data, P2
20	P10 CUEIN	I	Not Used	52	P63 (SEG11)	O	FL Segment Data, P3
21	RST	I	RESET	53	P62 (SEG10)	O	FL Segment Data, P4
22	P05 PSEL-CUE	I	Pause Select CUE	54	P61 (SEG9)	O	FL Segment Data, P5
23	P04 TRTIME	I	Tray Time	55	P60 (SEG8)	O	FL Segment Data, P6
24	P03 VCO	O	VCO Select	56	P57 (SEG7)	O	FL Segment Data, P7
25	P02 MBRAT	O	MB87014 RAT	57	P56 (SEG6)	O	FL Segment Data, P8
26	P01 MBDATA	O	MB87014 DATA	58	P55 (SEG5)	O	FL Segment Data, P9
27	P00 MBCLK	O	MB87014 CLK	59	P54 (SEG4)	O	FL Segment Data, P10
28	SYNC	O	Not Used	60	P53 (SEG3)	O	FL Segment Data, P11
29	CM	I	0V	61	P52 (SEG2)	O	FL Segment Data, P12
30	P47	I	Key Input, KEY 8	62	P51 (SEG1)	O	FL Segment Data, P13
31	P46	I	Key Input, KEY 7	63	P50 (SEG0)	O	FL Segment Data, P14
32	P45	I	Key Input, KEY 6	64	Vpp	-	Power Supply -25V, VFTD

SAA7345GP/M5 (DIGITAL DECODING IC WITH RAM)

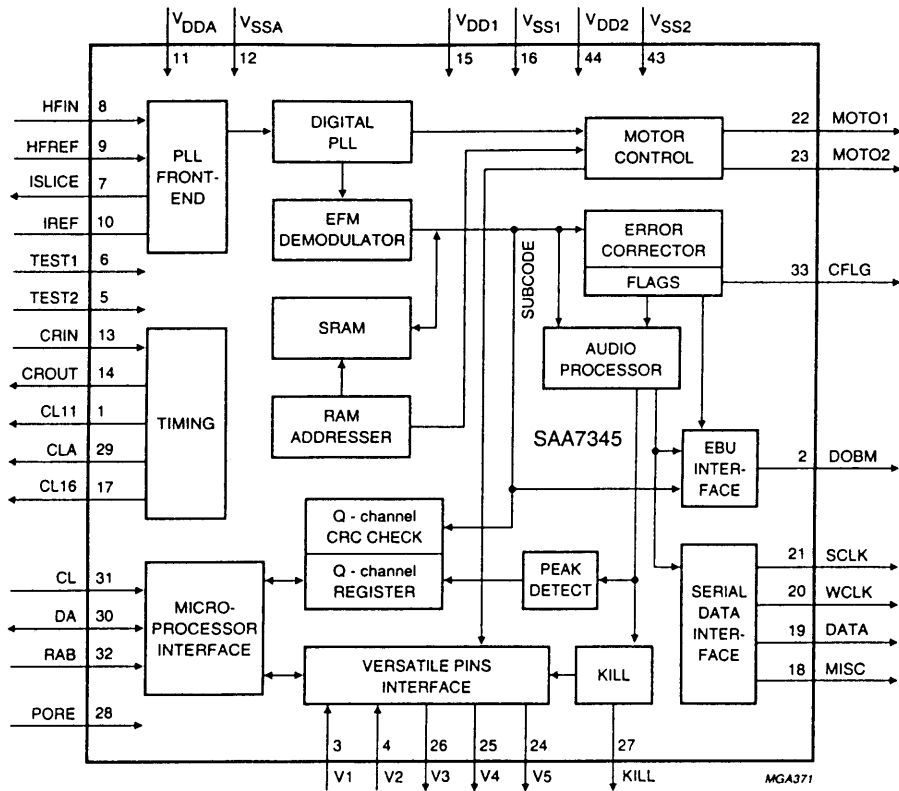

Pin Nbr	Pin Name	I/O	Function	Pin Nbr	Pin Name	I/O	Function
1	CL11	O	11.2896MHz clock output (3-state)	23	MOTO2	O	Motor output 2; versatile (3-state)
2	DOBM	O	Bi-phase mark output (externally buffered; 3-state)	24	V5	O	Versatile output pin
3	V1	I	Versatile input pin	25	V4	O	Versatile output pin
4	V2	I	Versatile input pin	26	V3	O	Versatile output pin (open-drain)
5	TEST2	I	Test input: this pin should be tied LOW	27	KILL	O	Kill output; programmable (open-drain)
6	TEST1	I	Test input; this pin should be tied LOW	28	PORE	I	Power-on reset enable input (active LOW)
7	ISLICE	O	Current feedback from data slicer	29	CLA	O	4.2336MHz microprocessor clock output
8	HFREF	I	Comparator signal input	30	DA	I/O	Interface data I/O line
9	HFREF	I	Comparator common-mode input	31	CL	I	Interface clock input line
10	IREF	-	Reference current pin (nominally $V_{DD}/2$)	32	RAB	I	Interface R/W and acknowledge input
11	V _{DDA}	-	Power supply (Analogue)	33	CFLG	O	Correction flag output (open-drain)
12	V _{SSA}	-	GND (Analogue)	34	—	-	No internal connection
13	CRIN	I	Crystal/resonator input, 16.9344 MHz	35	—	-	
14	CROUT	O	Crystal/resonator output	36	—	-	
15	V _{DD1}	-	Power supply 1 (Digital)	37	—	-	
16	V _{SS1}	-	GND 1 (Digital)	38	—	-	
17	CL16	O	16.9344MHz system clock output	39	—	-	
18	MISC	O	General purpose DAC output (3-state)	40	—	-	
19	DATA	O	Serial data output (3-state)	41	—	-	
20	WCLK	O	Word clock output (3-state)	42	—	-	
21	SCLK	O	Serial bit clock output (3-state)	43	V _{SS2}	-	GND 2 (Digital)
22	MOTO1	O	Motor output 1; versatile (3-state)	44	V _{DD2}	-	Power supply 2 (Digital)

TDA1549T/N1 (DAC)

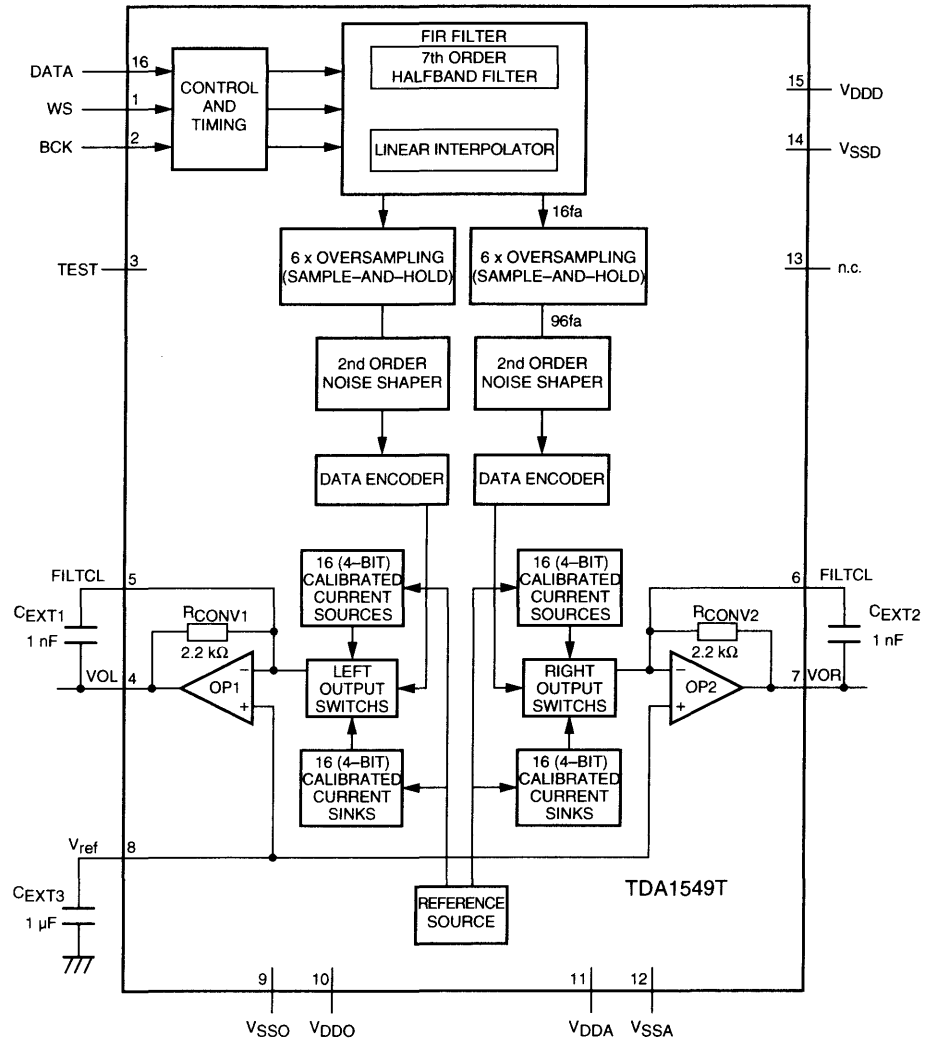

TDA1301T (DIGITAL SERVO)

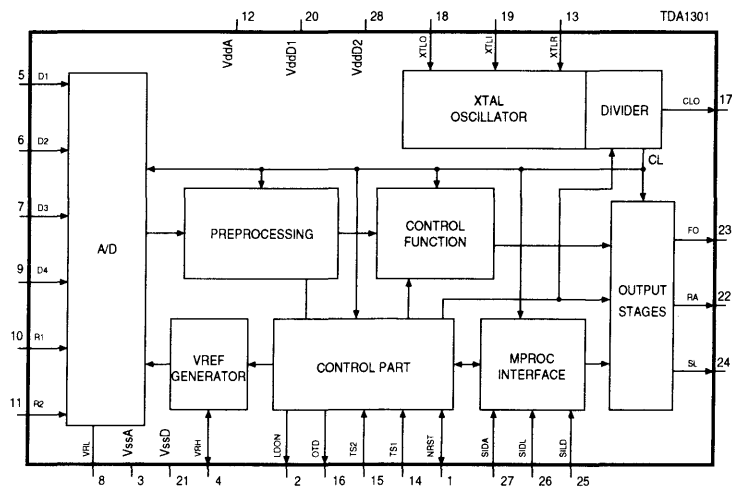

6. SERVICING HINTS (Pitch Control)

- The pitch of the PMD320 should be controlled by changing the clock frequency, which will be input to the CD Decoder Q503, with using PLL.
- PLL is composed of VCO QP02, Crystal Oscillator XP01, PLL IC QP01, PLL loop filter RP08, CP15 and CP16.
- At the beginning condition after switching ON, or when the 'CAL.' key is pressed, the clock data of the crystal oscillator will be input to the CD Decoder Q503 directly from Selector QP03.
- If either "PITCH +" key or "PITCH -" key is pressed, the clock data of VCO QP02 will be input to the CD Decoder Q503 directly from the Selector QP03.
- The PLL should be set into operation frequency by the microprocessor QF01 which located at pins 25, 26 and 27.

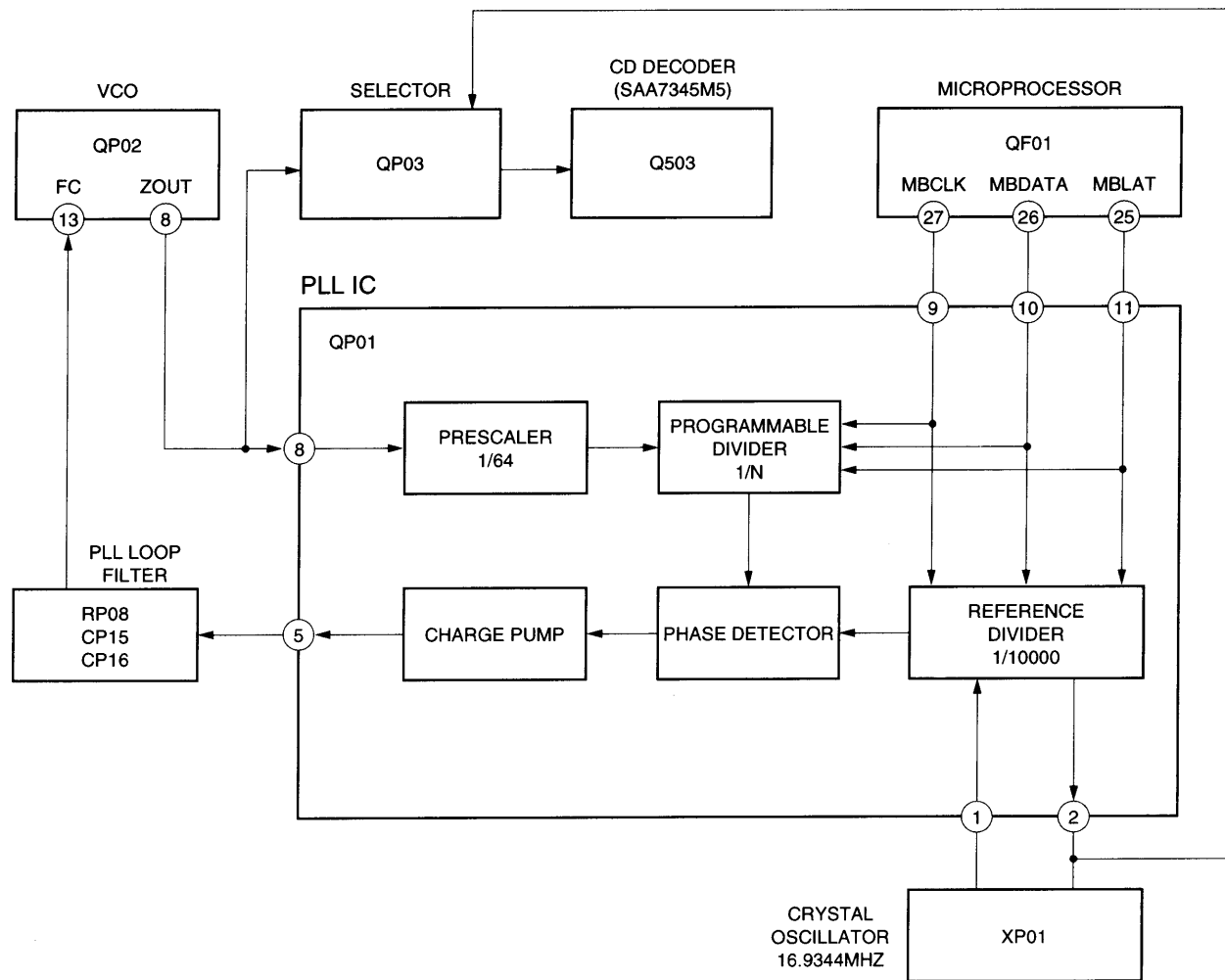

Pitch Control

The CD playback speed and pitch can be varied by +/- 12%.

Caution:

When the CD playback speed is varied with the PMD320/PMD321 pitch control, the sample rate is varied and digital recording may not be possible.

Increasing up the CD playback speed.

1. Press the **[PITCH +]** button. Display the current playback speed.
(eg. the playback speed is +0.1%.)

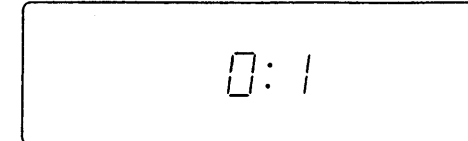

2. Every time pressing the **[PITCH +]** button, the playback speed is 0.1% up.
3. After 1.5 seconds pressing the **[PITCH +]** button, the display returns to normal.

Decreasing the CD playback speed.

1. Press the **[PITCH -]** button. Display the current playback speed.
(eg. the playback speed is -1.5%.)

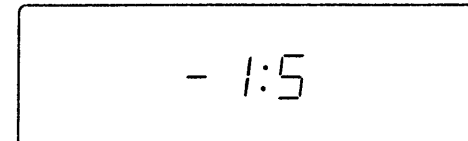

2. Every time pressing the **[PITCH -]** button, the playback speed is 0.1% down.
3. After 1.5 seconds pressing the **[PITCH -]** button, the display returns to normal.

Returning to the normal speed

There are 2 ways to return the normal speed.

- a. Press the **[CAL.]** button.
 - b. Change the **[PITCH +]** or **[PITCH -]** button to set the playback speed to 0.0%.
- * When the CD playback speed is varied (including the 0.0% speed), the indicator ":" on the display blinks. We recommend using the **[CAL.]** button to return to normal playback for higher clock accuracy.

Digital audio equipment, such as a D/A converter, digital sound processor, etc., may not lock to the digital output signal, when you connect the digital output terminal to the digital audio equipment and change the pitch. Press the **[CAL.]** button to set the pitch to 0.0%.

AUDIO CUE (only PMD321)

This function skips the silent passage at the beginning of a track and start playback just before the audio begins. Press the **[CUE]** button.

The "PLAY" indicator will blink, indicating the AUDIO CUE mode.



You can now select a track with the PLAY and numeric (0-9) **[<<]** or **[>>]** buttons. The PMD321 will cue to the beginning of the audio of the selected track.

Starting tracks

- Press the **[PAUSE]** button.

Releasing the AUDIO CUE mode

- Press the **[CUE]** button.
- * The sound detecting level is approx. -42.1 dB. Tracks which are not recorded over this level do not work correctly.
- * The beginning of fade-in tracks may not be played back.

FADER START REMOTE CONNECTION

The fader start connection will enable you to start and stop playback of a selected track by means of an external switch.

This can be the fader start switch, Built into a mixing desk.

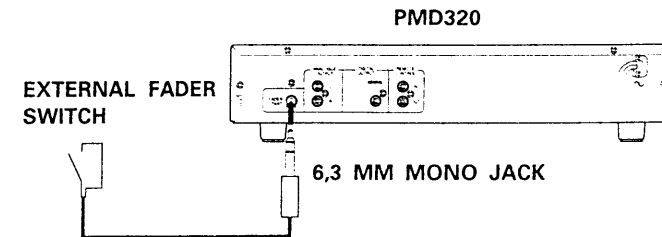

OPERATION

MODE	OPEN	CLOSE
PLAY	NO ACTION	GO TO PAUSE
PAUSE	START PLAYBACK	NO ACTION

Playback is started when opening the fader switch. When the fader switch is closed, the CD-player goes to pause mode.

7. WAVE FORM

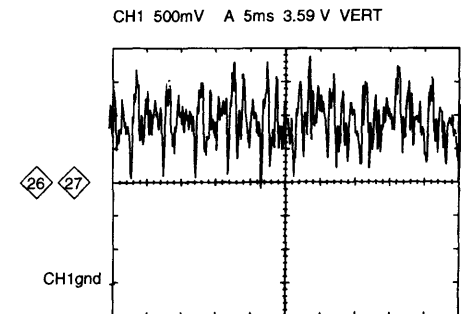
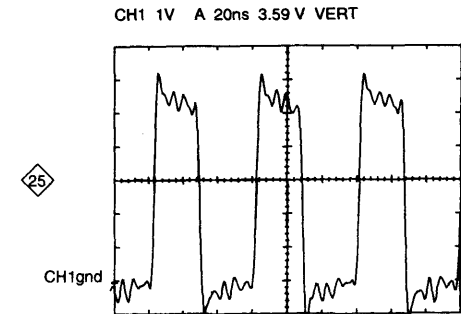
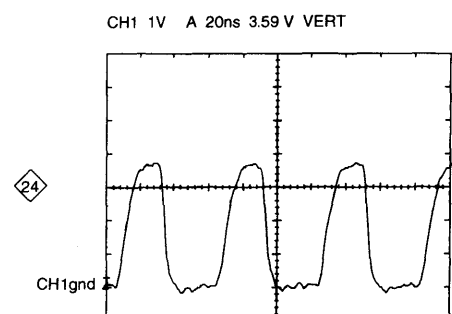
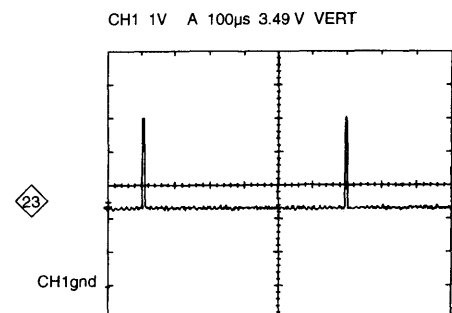
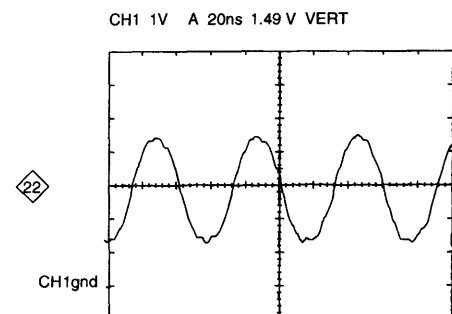
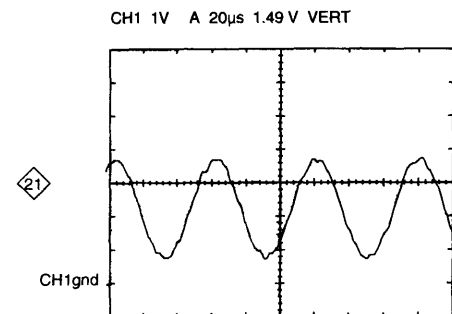
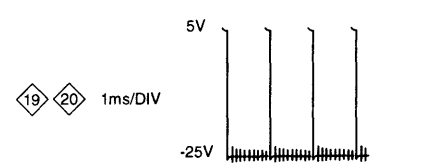
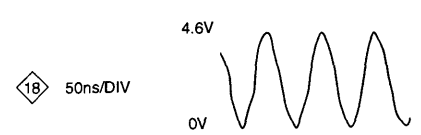
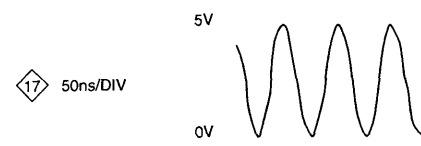
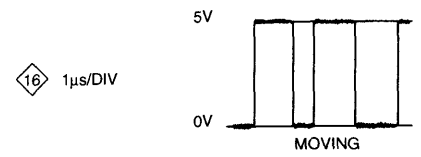
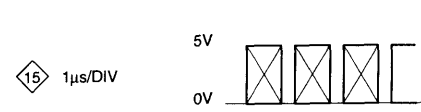
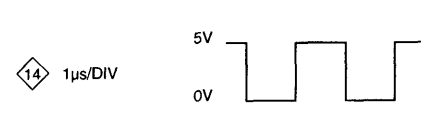
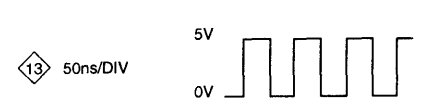
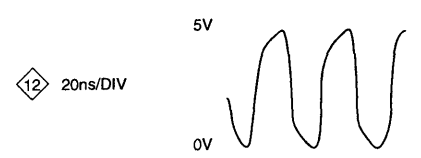
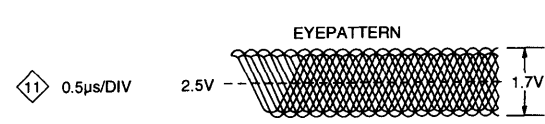
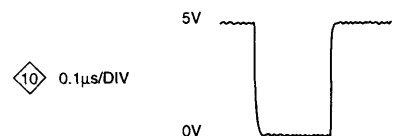
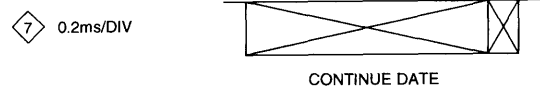
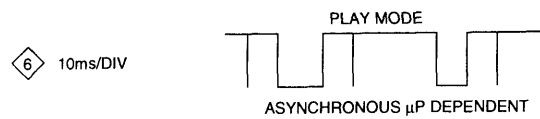
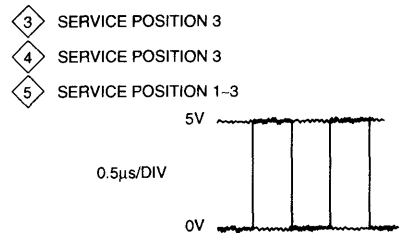
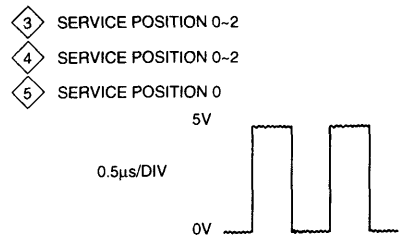
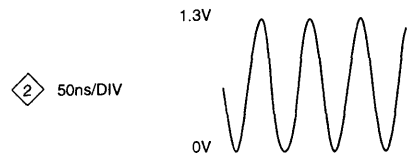
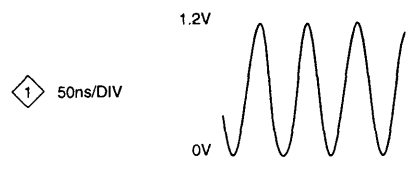

8. BLOCK DIAGRAM

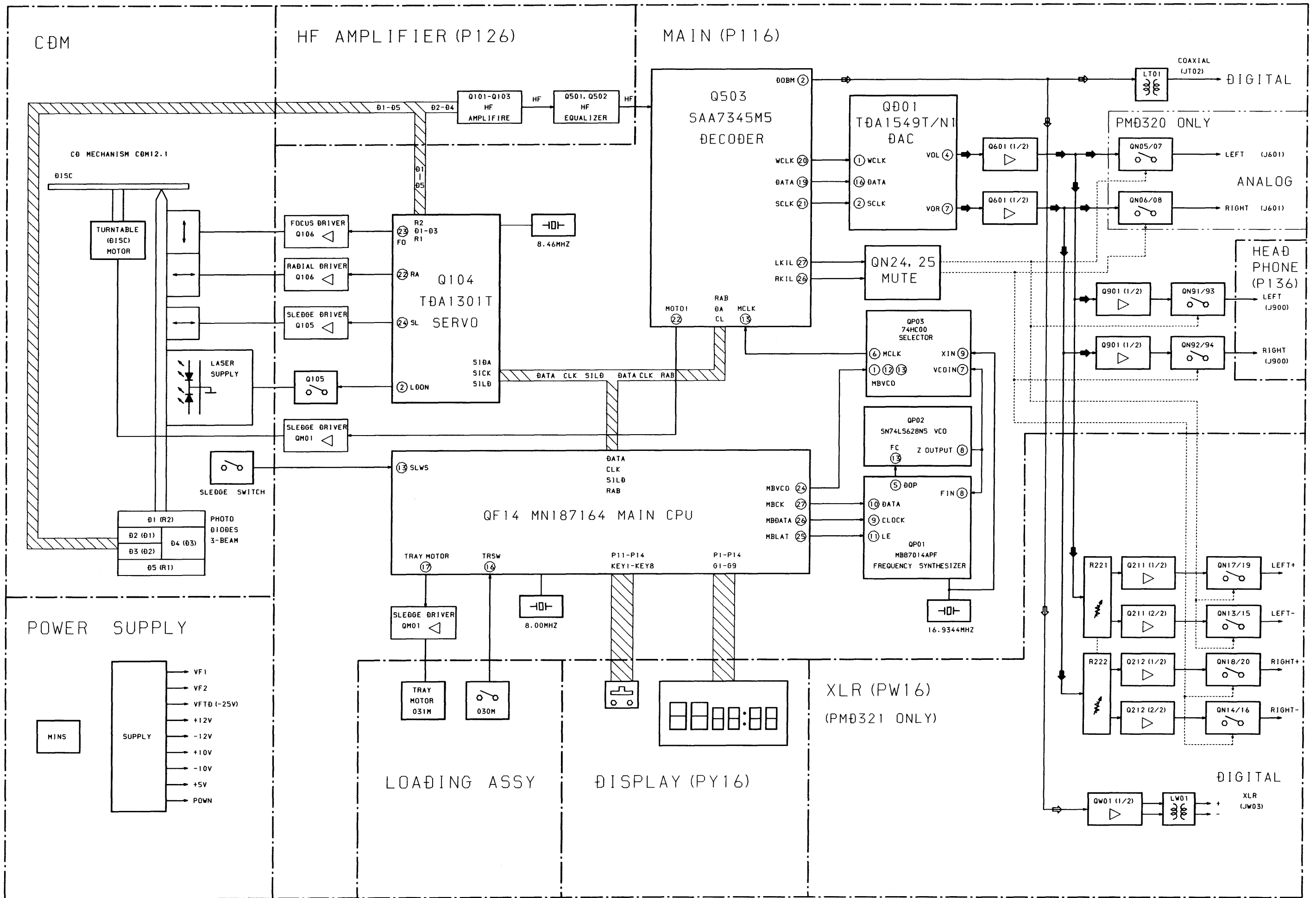

9. SCHEMATIC DIAGRAMS AND PARTS LOCATION (PATTERN SIDE)

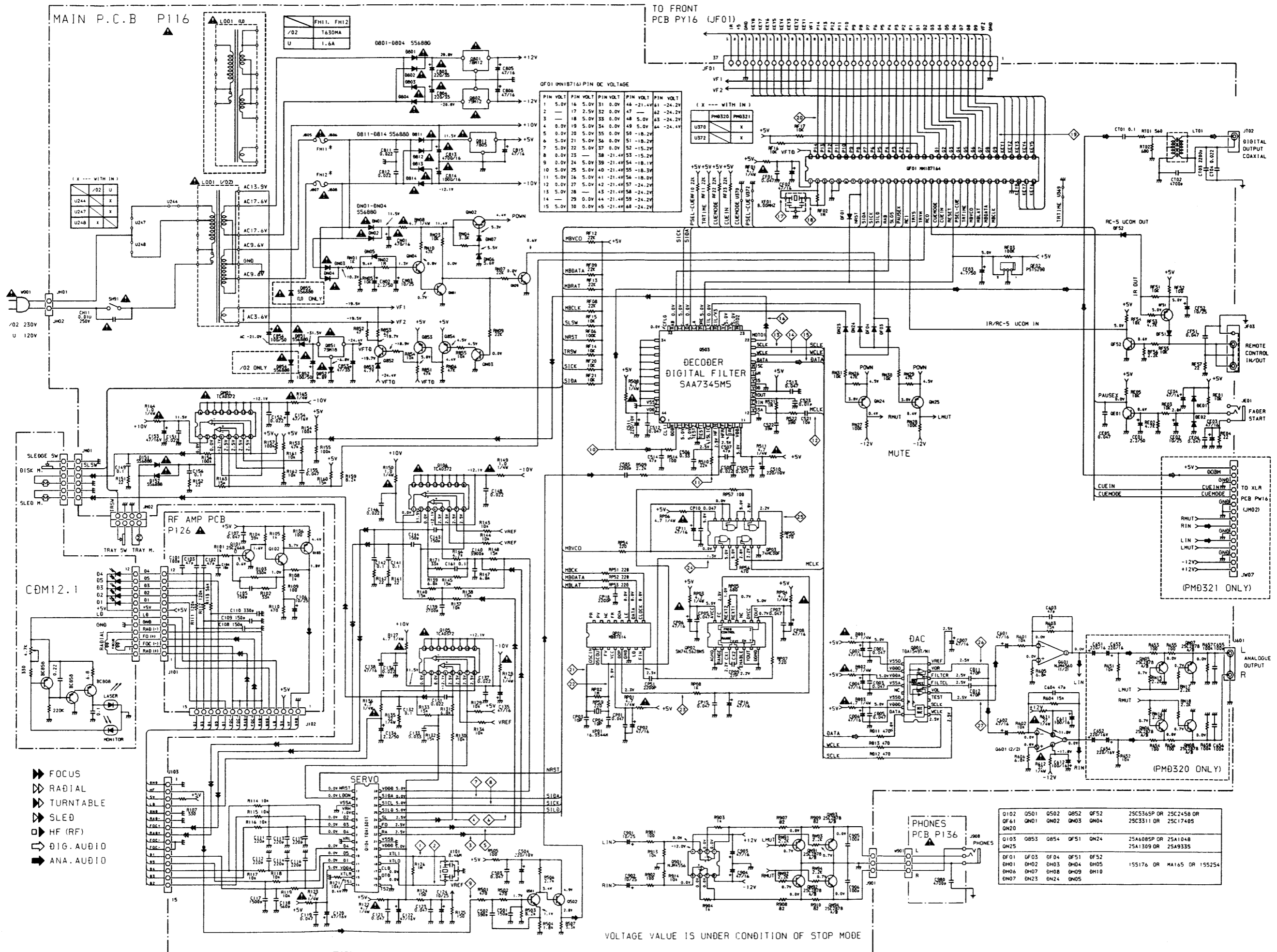

QE01 QN08 QN06 QN05,Q601 QN07 QN01-QN04,QN25,QN20,QN24, Q801,Q802
 QP01,QP02 QD01,QP03 QM01 Q811,Q105 Q854,Q853 Q106,Q851 Q852
 QN94,Q901,QN92 QN91 QN93 Q503 QF02 QF52,Q502,QF51 Q501 QF61 QF01 Q104

P116

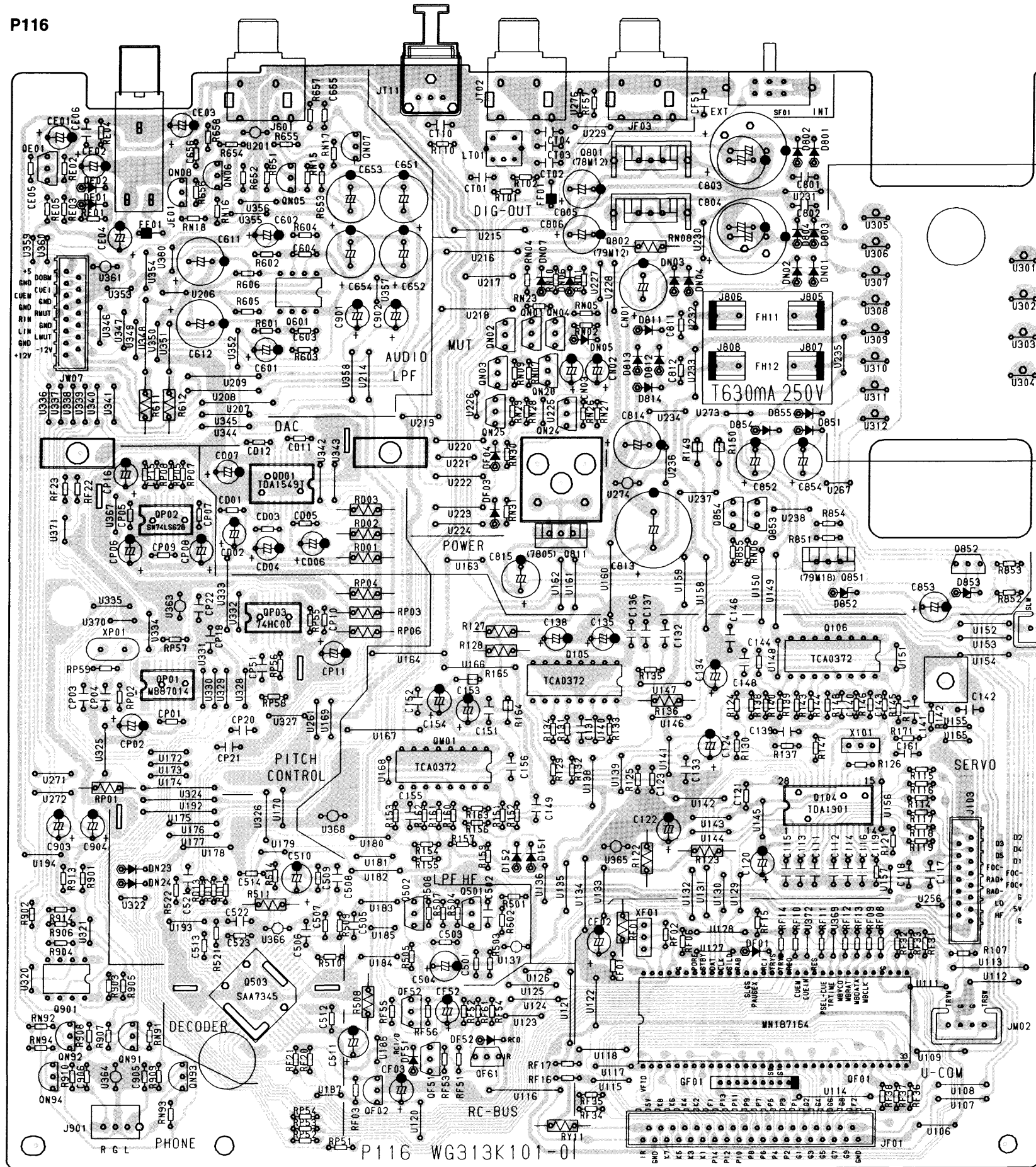

P116 WG313K101-0

CAUTION: FOR CONTINUED PROTECTION AGAINST FIRE HAZARD, REPLACE ONLY WITH SAME TYPE FUSE.

ATTENTION: AFIN D'ASSURER PERMANENTE UNE PROTECTION CONTRE LES RISQUES D'INCENDIE, REMPLACER UNIQUEMENT PAR UN FUSIBLE DE MEME TYPE FUSE.

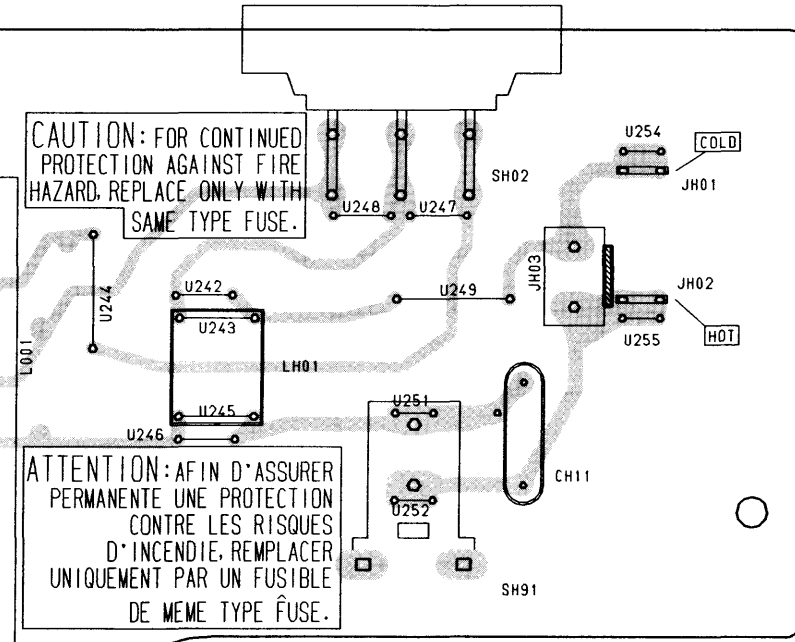

P136

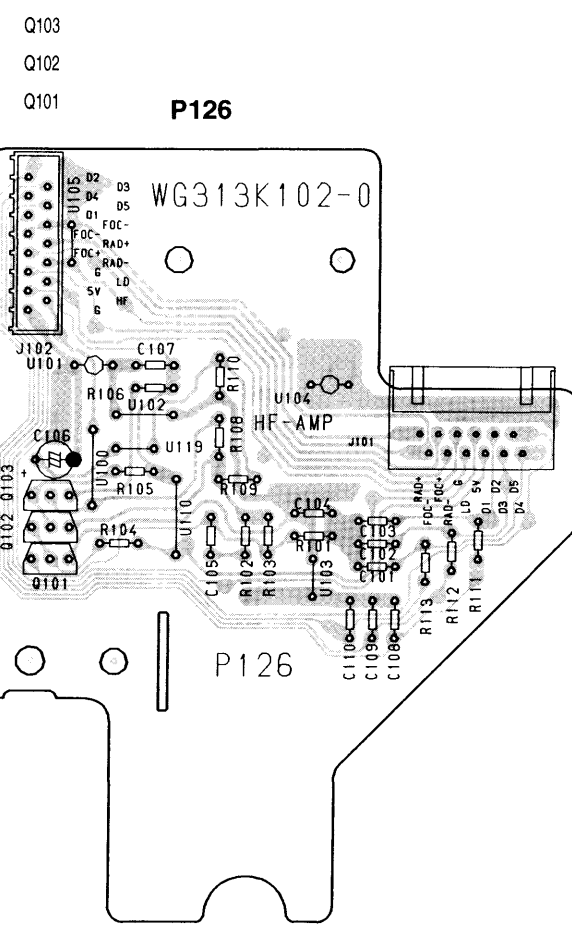
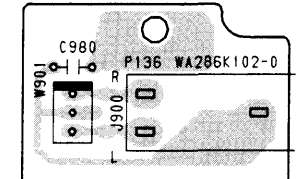

P126

P126

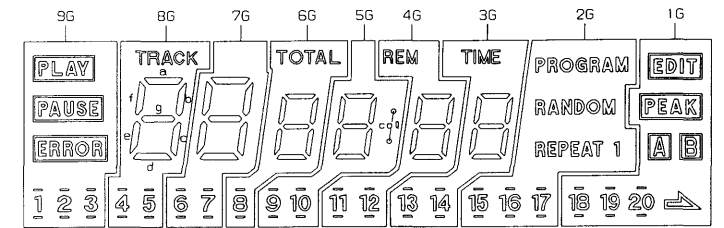
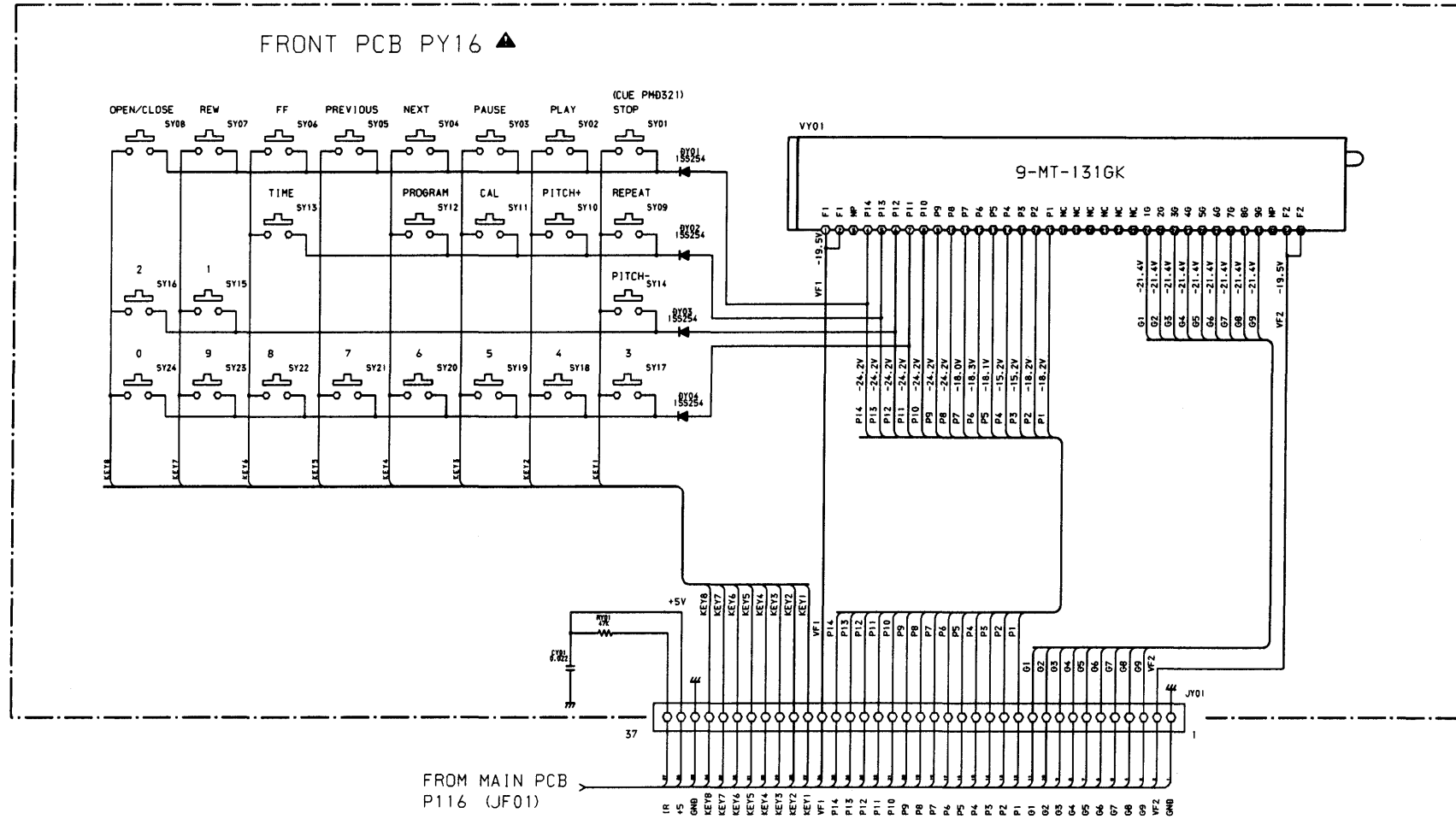

ANODE CONNECTION

	9G	8G	7G	6G	5G	4G	3G	2G	1G
P1	-	a	a	a	a	a	a	PROGRAM	PEAK
P2	(1)	b	b	b	b	b	b	15	18
P3	(1)	c	c	c	c	c	c	(15)	(18)
P4	(1)	d	d	d	d	d	d	1	▶
P5	-	e	e	e	e	e	e	REPEAT	▶
P6	ERROR	f	f	f	f	f	f	-	▶
P7	(2)	g	g	g	g	g	g	(15)	(18)
P8	2	(4)	-	TOTAL	col	REW	(13)	(16)	(19)
P9	(2)	4	(6)	-	(9)	(11)	13	16	19
P10	(3)	(4)	6	(8)	9	11	(13)	(16)	(19)
P11	3	(5)	(6)	8	(9)	(11)	(14)	(17)	(20)
P12	(3)	5	(7)	(8)	(10)	(12)	14	17	20
P13	PLAY	(5)	7	-	10	12	(14)	(17)	(20)
P14	PAUSE	TRACK	(7)	-	(10)	(12)	TIME	RANDOM	EDIT

9-MT-131GK
ANODE CONNECTION

PY16

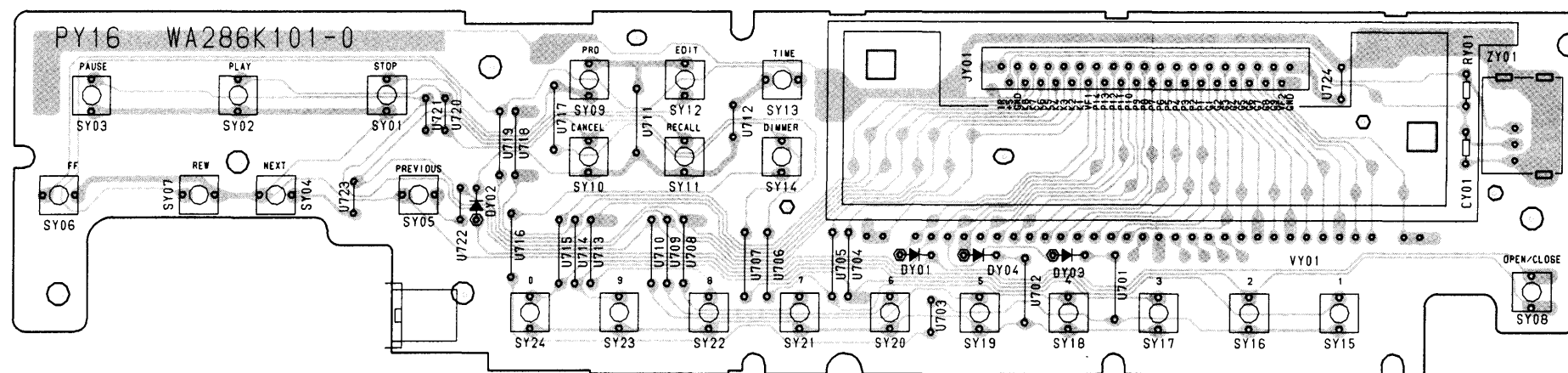

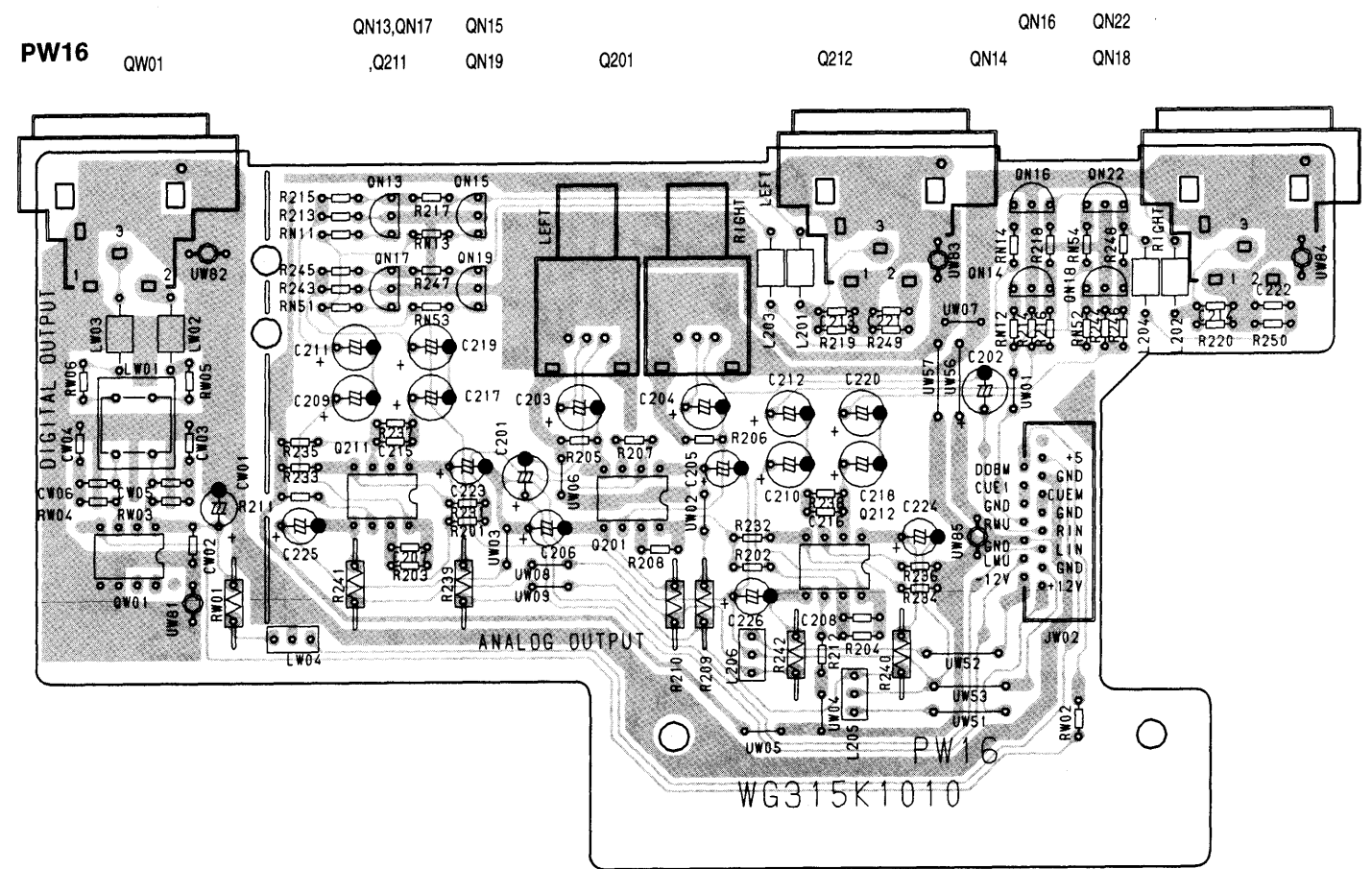
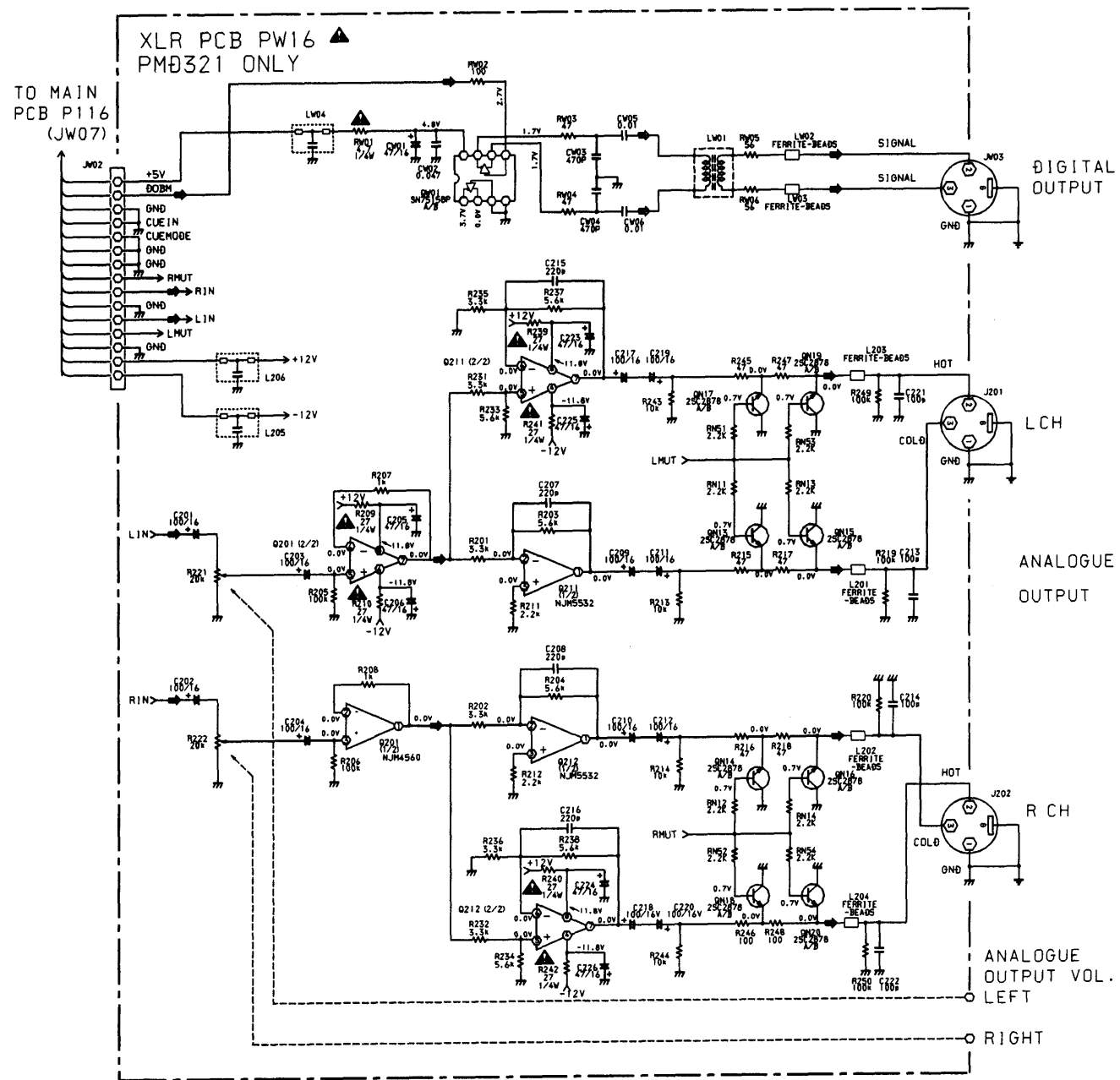

10. EXPLODED VIEW AND PARTS LIST

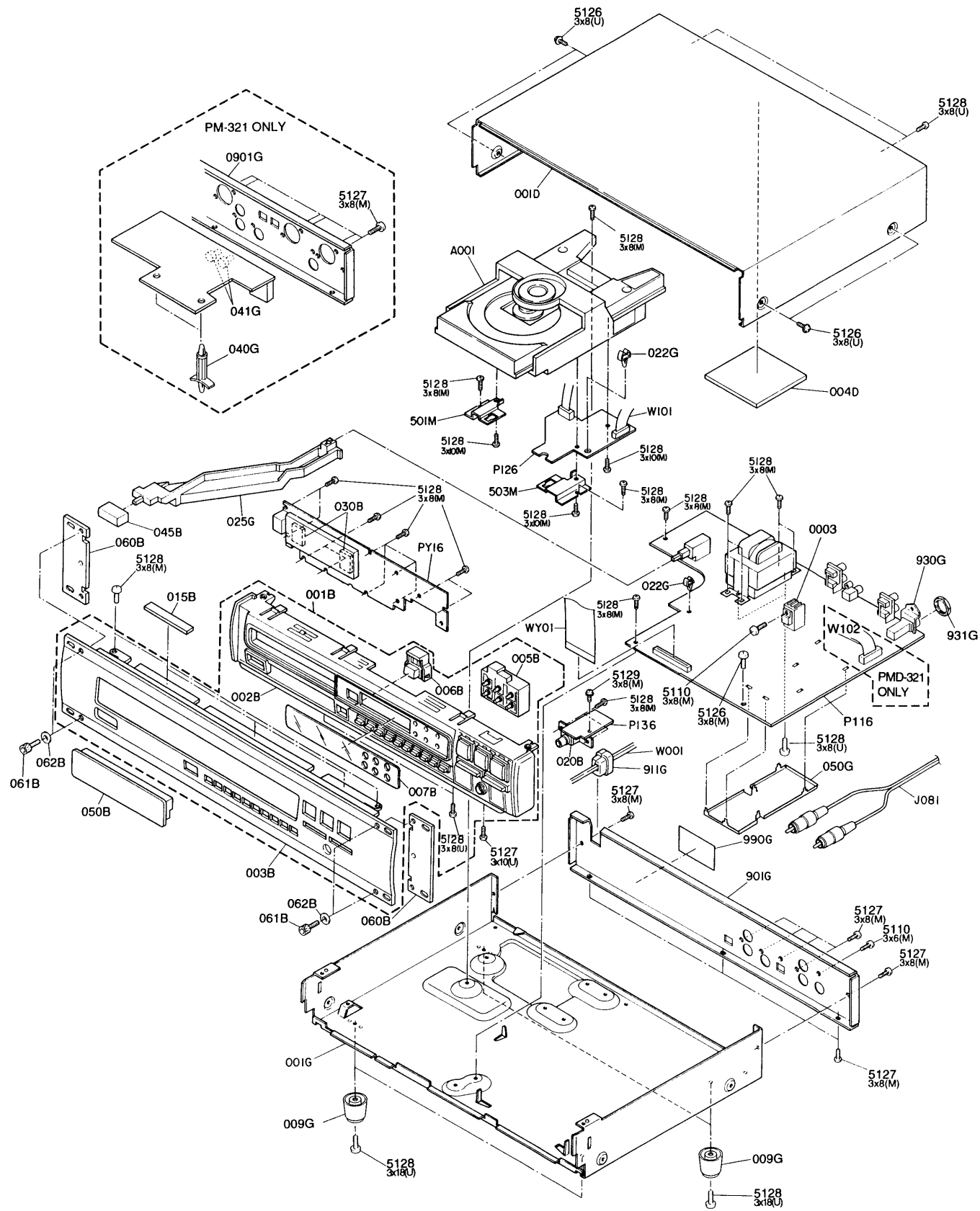

[VERS.:VERSION, U:U.S.A, F:Japan, K:Far East, /XX:Europe]

POS. NO.	VERS. COLOR	PART NO. (For EUROPE)	DESCRIPTION	PART NO. (For U/K/F)
002B	/02		CHASSIS, FRONT PL	285K105210
002B	U		CHASSIS, FRONT PL	285K105020
003B			FRONT PANEL, AL [PMD320]	313K248010
003B			FRONT PANEL, AL [PMD321]	315K248010
005B		4822 410 62898	BUTTON, D3 GOLD HOT STAMPED	285K270020
006B	U		BUTTON, OPEN/CLOSE	285K270030
006B	/02		BUTTON, OPEN/CLOSE	285K270230
007B			WINDOW [PMD320]	313K158010
045B		4822 410 62744	BUTTON, POWER	285K270010
050B		4822 454 30491	ESCUTCHEON, DISC TRAY FRONT	285K063010
060B			BRACKET, RACK MOUNT	313K160010
061B			H.S. HEAD BOLT	52730408U0
062B		4822 532 11287	WASHER	59046502G0
001D			LID, TOP COVER	285K257010
009G		4822 462 41771	LEG (BLACK MOLD)	229K057010
025G		4822 403 70989	LINK, POWER SW.	285K121010
911G		4822 532 60948	BUSHING, AC CORD BUSH	450H259010
▲W001	U		A.C. POWER CORD	YC01800330
▲W001	/02	4822 321 10428	A.C. POWER CORD	YC01800340
W102		4822 321 63052	JUMPER LEAD SUMI CARD 15P 60MM [PMD321]	YU15060520
WY01	/02		JUMPER LEAD SUMI CARD 37P 120MM	YU37120500
WY01	U		JUMPER LEAD SUMI CARD 37P 120MM	YU37120520
001T	U		PACKING USER MANUAL [PMD320/321]	313K851250
001T	/02		USER MANUAL [PMD320/321]	313K851310
J081		4822 321 21438	CONNECTIVE CORD, RCA [PMD320]	ZD01000330

LOADER

DETAIL I

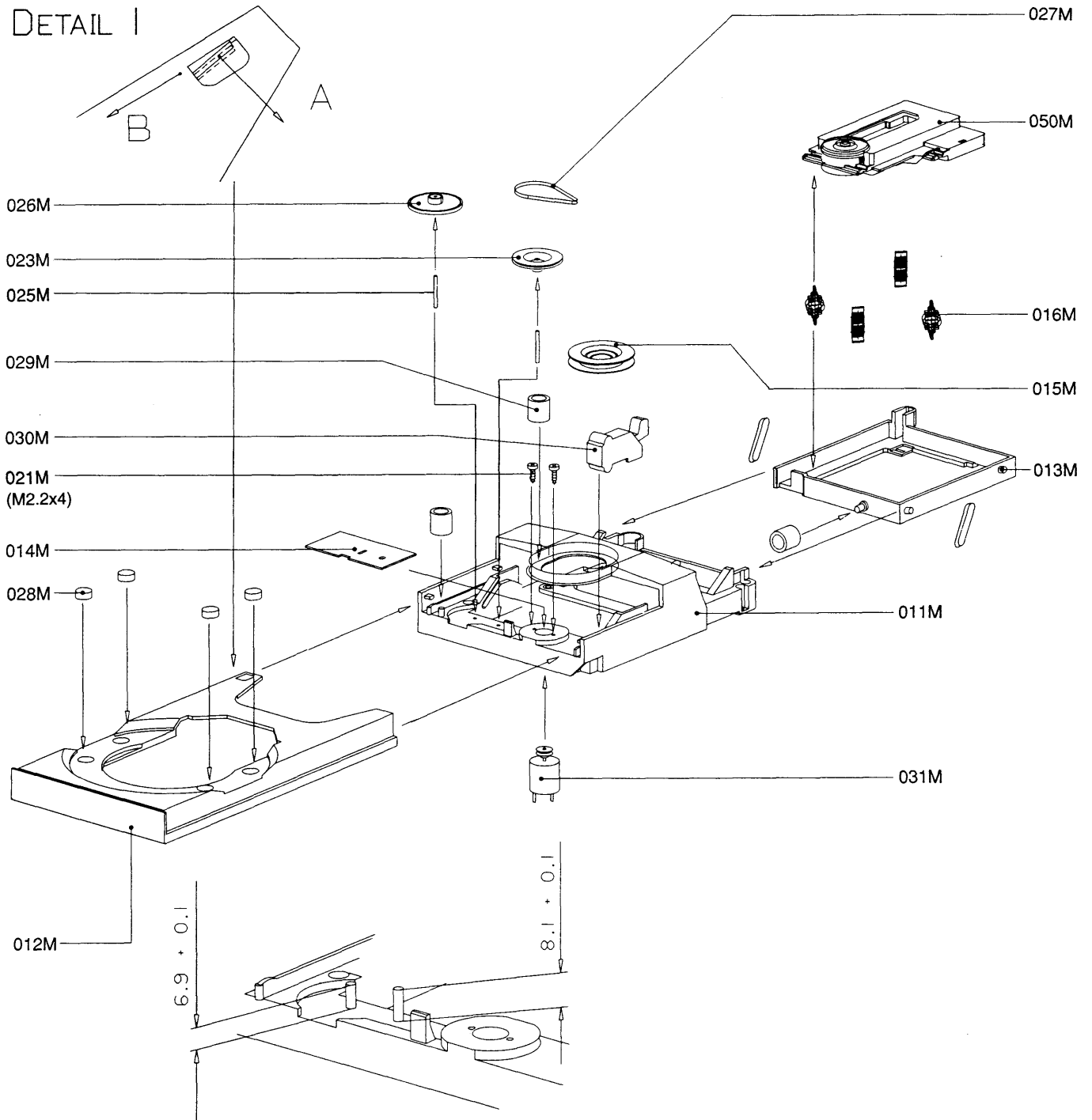

[VERS.:VERSION, U:U.S.A, F:Japan, K:Far East, /XX:Europe]

POS. NO.	VERS. COLOR	PART NO. (For EUROPE)	DESCRIPTION	PART NO. (For U / K / F)
011M		4822 444 50678	CHASSIS	271K105030
012M		4822 444 50679	TRAY, SLIDE	271K163010
013M		4822 464 50895	SUBCHASSIS	271K105040
015M		4822 402 61412	CLAMPER ASSY	271K005010
016M		4822 325 50215	BUFFER, SUSPENSION	271K056010
021M		4822 502 12001	SCREW	271K010010
023M		4822 528 81465	PULLEY	271K262010
026M		4822 528 81464	GEAR, DRIVE PINION	271K058010
027M		4822 358 31168	BELT, DRIVE	271K264010
028M		4822 325 80511	BUFFER, ORNAMENTAL TULE	271K056030
029M		4822 325 60379	BUFFER, DAMPING GROMMET	271K056020
030M		4822 276 13222	MINI SW, SINMEI QAS12299	*SM000300R
031M		4822 361 21492	D.C.MOTOR	*MM000660R
050M		4822 691 30278	MECHANISM, CDM12.1	271K304560

11. ELECTRICAL PARTS LIST

ASSIGNMENT OF COMMON PARTS CODES.

RESISTOR

R*** : (1) GD05 x x x 140, Carbon film fixed resistor, ±5% 1/4W
R*** : (2) GD05 x x x 160, Carbon film fixed resistor, ±5% 1/6W

① ——— Resistance value

Examples ;

① Resistance value

0.1 Ω.....001	10 Ω.....100	1 kΩ.....102	100 kΩ.....104
0.5 Ω.....005	18 Ω.....180	2.7 kΩ.....272	680 kΩ.....684
1 Ω.....010	100 Ω.....101	10 kΩ.....103	1 MΩ.....105
6.8 Ω.....068	390 Ω.....391	22 kΩ.....223	4.7 MΩ.....475

(Note) Please distinguish 1/4W from 1/6W by the shape of parts used actually.

C*** : CERAMIC CAP.

(1) DD1x x x x 370, Ceramic capacitor
 Disc type
 Temp. coeff. P350 ~ N1000, 50V

① ②
 ——— Capacity value
 ——— Tolerance

Examples ;

① Tolerance (Capacity deviation)

± 0.25pF.....0
± 0.5pF.....1
± 5%.....5

*Tolerance of COMMON PARTS handled here are as follows :

0.5pF ~ 5pF.....	± 0.25pF
6pF ~ 10pF.....	± 0.5pF
12pF ~ 560pF.....	± 5%

② Capacity value

0.5 pF.....005	3 pF.....030	100 pF.....101
1 pF.....010	10 pF.....100	220 pF.....221
1.5 pF.....015	47 pF.....470	560 pF.....561

C*** : CERAMIC CAP.

(1) DK16 x x x 300, High dielectric constant ceramic capacitor
 Disc type
 Temp. chara. 2B4, 50V

① ——— Capacity value

Examples ;

① Capacity value

100 pF.....101	1000 pF.....102	10000 pF.....103
470 pF.....471	2200 pF.....222	

C*** : ELECTROLY CAP. (≠), FILM CAP. (≡)

(1) EA x x x x x 10, Electrolytic capacitor
 One-way lead type, Tolerance ± 20%

① ②
 ——— Working voltage
 ——— Capacity value

Examples ;

① Capacity value

0.1 μF.....104	4.7 μF.....475	100 μF.....107
0.33 μF.....334	10 μF.....106	330 μF.....337
1 μF.....105	22 μF.....226	1100 μF.....118
		2200 μF.....228

② Working voltage

6.3 V.....006	25 V.....025
10 V.....010	35 V.....035
16 V.....016	50 V.....050

(2) DF15 x x x 350 → Plastic film capacitor
 DF15 x x x 310 → One-way type, Mylar ± 5% 50V
 DF16 x x x 310 → Plastic film capacitor
 One-way type, Mylar ± 10% 50V

① ——— Capacity value

Examples ;

① Capacity value

0.001 μF (1000pF).....102	0.1 μF.....104
0.0018 μF.....182	0.56 μF.....564
0.01 μF.....103	1 μF.....105
0.015 μF.....153	

NOTE : 1) The above CODES (**R*****, **R*****, **C*****, **C***** and **C*****) are omitted on the schematic diagram in some case.
 2) On the occasion, be confirmed common parts on the parts list.
 3) Refer to "Common Parts List" for the other common parts (**R105**, **DD4**, **DK4**).

NOTE ON SAFETY FOR FUSIBLE RESISTOR :

The suppliers and their type numbers of fusible resistors aer as follows :

1. KOA Corporation

Part No.	Type No.	Description
NH05 x x x 140	RF25S x x x x Ω J	(± 5% 1/4W)
NH05 x x x 120	RF50S x x x x Ω J	(± 5% 1/2W)
NH85 x x x 110	RF73B2A x x x x Ω J	(± 5% 1/10W)
NH85 x x x 140	RF73B2E x x x x Ω J	(± 5% 1/4W)

└ * Resistance value └ Resistance value
 (0.1 - 10kΩ)

2. Matsushita Electronic Components Co., Ltd

Part No.	Type No.	Description
NF05 x x x 140	ERD-2FCJ x x x	(± 5% 1/4W)
RF05 x x x 140		
NF02 x x x 140	ERD-2FCG x x x	(± 2% 1/4W)
RF02 x x x 140		

└ * Resistance value └ * Resistance value

Examples :

* Resistance value

0.1 Ω.....001	10 Ω.....100	1 kΩ.....102	100 kΩ.....104
0.5 Ω.....005	18 Ω.....180	2.7 kΩ.....272	680 kΩ.....684
1 Ω.....010	100 Ω.....101	10 kΩ.....103	1 MΩ.....105
6.8 Ω.....068	390 Ω.....391	22 kΩ.....223	4.7 MΩ.....475

ABBREVIATION AND MARKS

1	ANT. : ANTENNA	2	BATT. : BATTERY
3	CAP. : CAPACITOR	4	CER. : CERAMIC
5	CONN. : CONNECTING	6	DIG. : DIGITAL
7	HP : HEADPHONE	8	MIC. : MICROPHONE
9	μ-PRO : MICROPROCESSOR	10	REC. : RECORDING
11	RES. : RESISTOR	12	SPK : SPEAKER
13	SW : SWITCH	14	TRANSF. : TRANSFORMER
15	TRIM. : TRIMMING	16	TRS. : TRANSISTOR
17	VAR. : VARIABLE	18	X'TAL : CRYSTAL
19		20	
21		22	
23		24	
25		26	
27		28	
29		30	

NOTE ON SAFETY :

Symbol **▲** Fire or electrical shock hazard. Only original parts should be used to replace any part marked with symbol **▲**. Any other component substitution (other than original type), may increase risk of fire or electrical shock hazard.

安全上の注意 :

▲ がついている部品は、安全上重要な部品です。必ず指定されている部品番号の部品を使用して下さい。

POS. NO.	VERS. COLOR	PART NO. (For EUROPE)	DESCRIPTION	PART NO. (For U/K/F)	POS. NO.	VERS. COLOR	PART NO. (For EUROPE)	DESCRIPTION	PART NO. (For U/K/F)
			PW16-XLR CIRCUIT BOARD [PMD321 ONLY]					PY16-FRONT CIRCUIT BOARD	
			PW16-CAPACITORS					PY16-CAPACITOR	
CW01		4822 124 41539	ELECT 47 μ F 16V RA-2	OA47601620	CY01			CER. 0.047 μ F +80%-20%	DA17473110
CW02			CER. 0.047 μ F +80%-20%	DA17473110				PY16-RESISTOR (COMMON)	
CW03			CER. 470 PF \pm 10%	DA16471110				CARBON FILM FIXED RESISTOR,	
CW04			CER. 470 PF \pm 10%	DA16471110				\pm 5% 1/6W:	
CW05			CER. 0.01 μ F \pm 20%	DA17103110				PY01	
CW06			CER. 0.01 μ F \pm 20%	DA17103110				PY16-SEMICONDUCTORS	
C201					DY01				
C204		4822 124 90354	ELECT 100 μ F 16V RA-2	OA10701620	§		4822 130 32362	DIODE, 1SS176,MA165,1SS254	HD20002000
C205		4822 124 41539	ELECT 47 μ F 16V RA-2	OA47601620	DY04			30V 0.1A	
C206		4822 124 41539	ELECT 47 μ F 16V RA-2	OA47601620				PY16-MISCELLANEOUS	
C207			CER. 270 PF \pm 10%	DA16221110				JACK, 37 PIN FFC (L-TYPE)	YJ06011470
C208			CER. 270 PF \pm 10%	DA16221110					
C209									
C212		4822 124 90354	ELECT 100 μ F 16V RA-2	OA10701620			4822 276 20508	PUSH SW, TACT SW	SP01011280
C213			CER. 100 PF \pm 10%	DA16101110					
C214			CER. 100 PF \pm 10%	DA16101110			4822 276 13296	PUSH SW, TACT SW (100GF)	SP01011880
C215			CER. 270 PF \pm 10%	DA16221110					
C216			CER. 270 PF \pm 10%	DA16221110					
C217							4822 130 91287	DISPLAY UNIT, 9MT131GK FTD	HQ3091441
C220		4822 124 90354	ELECT 100 μ F 16V RA-2	OA10701620					
C221			CER. 100 PF \pm 10%	DA16101110					
C222			CER. 100 PF \pm 10%	DA16101110					
C223									
C226		4822 124 41539	ELECT 47 μ F 16V RA-2	OA47601620				P116-MAIN CIRCUIT BOARD	
			PW16-RESISTORS					P116-CAPACITORS	
▲RW01		4822 111 90967	FUSE 4.7 Ω \pm 5% 1/4W	NF05047140	CD01		4822 124 41539	CER. 0.047 μ F +80%-20%	DA17473110
▲R209		4822 052 10279	FUSE 27 Ω \pm 2% 1/4W	NF02270140	CD02			ELECT 47 μ F 10V	OA47601620
▲R210		4822 052 10279	FUSE 27 Ω \pm 2% 1/4W	NF02270140	CD03			CER. 0.047 μ F +80%-20%	DA17473110
R221		4822 101 30882	VARIABLE RESIST RK09L1120 20K Ω	RB02030350	CD04		4822 124 41539	ELECT 47 μ F 16V	OA47601620
R222		4822 101 30882	VARIABLE RESIST RK09L1120 20K Ω	RB02030350	CD05			CER. 0.047 μ F +80%-20%	DA17473110
▲R239					CD06		4822 124 41539	ELECT 47 μ F 16V	OA47601620
§		4822 111 31049	FUSE 27 Ω \pm 2% 1/4W	NF02270140	CD07			ELECT 47 μ F 16V	OA47601620
▲R242					CD11			FILM 470 PF \pm 5% 50V	DF15471350
					CD12			FILM 470 PF \pm 5% 50V	DF15471350
			PW16-RESISTOR (COMMON)		CE01		4822 124 90357	ELECT 2.2 μ F 50V	OA22505020
			CARBON FILM FIXED RESISTOR,		CE02		4822 124 41534	ELECT 10 μ F 25V	OA10602520
			\pm 5% 1/6W:		CE03		4822 124 41539	ELECT 47 μ F 16V	OA47601620
			RN11-RN14, RN51-RN54, RW02-RW06,		CE04		4822 124 41539	ELECT 47 μ F 16V	OA47601620
			R201-R208, R211-R220, R231-R238,		CE05			CER. 0.047 μ F +80%-20%	DA17473110
			R243-R250		CE06			CER. 0.047 μ F +80%-20%	DA17473110
			PW16-SEMICONDUCTORS		CF01			CER. 0.047 μ F +80%-20%	DA17473110
QN13		4822 130 43818	TRS. 2SC2878 (A OR BRANK)	HT328782A0	CF02		4822 124 41539	ELECT 47 μ F 16V	OA47601620
§					CF03		4822 124 22274	ELECT 4.7 μ F 50V	OA47505020
QN19		4822 130 43818	TRS. 2SC2878 (A OR BRANK)	HT328782A0	CF51			CER. 0.047 μ F +80%-20%	DA17473110
QN22		5322 209 60473	IC, SN75158/P	HC10071370	CF52		4822 124 41534	ELECT 10 μ F 25V	OA10602520
QW01					▲CH11			FILM 0.01 μ F \pm 20% 250V	DF77103500
Q201		4822 209 83274	IC, NJM4560D	HC10007090	▲CN01		4822 124 22277	ELECT 470 μ F 16V	OA47701620
Q211		4822 209 83662	IC, NJM5532D	HC10023090	CN02		4822 124 90357	ELECT 2.2 μ F 50V	OA22505020
Q212		4822 209 83662	IC, NJM5532D	HC10023090	CN03		4822 124 41534	ELECT 10 μ F 25V	OA10602520
			PW16-MISCELLANEOUS		CP01			CER. 0.047 μ F +80%-20%	DA17473110
JW02		4822 265 41528	JACK, ZC-115 15P	YJ07009730	CP02		4822 124 41539	ELECT 47 μ F 16V	OA47601620
JW03		4822 267 31946	PLUG, CANNON YKF52-5003	YP10003340	CP03			CER. 10 PF \pm 0.5PF	DD11100300
J201		4822 267 31946	PLUG, CANNON YKF52-5003 (L-CH)	YP10003340	CP04			CER. 10 PF \pm 0.5PF	DD11100300
J202		4822 267 31946	PLUG, CANNON YKF52-5003 (R-CH)	YP10003340	CP05			CER. 0.047 μ F +80%-20%	DA17473110
LW01		4822 148 81381	PULSE TRANSF. TC-1086-26	TP33842010	CP06		4822 124 41539	ELECT 47 μ F 16V	OA47601620
LW02		4822 158 60605	FERRITE CORE, BEADS (B-01-RT)	FC90050060	CP07			CER. 0.047 μ F +80%-20%	DA17473110
LW03		4822 158 60605	FERRITE CORE, BEADS (B-01-RT)	FC90050060	CP08		4822 124 41539	ELECT 47 μ F 16V	OA47601620
LW04		4822 242 73843	EMI FILTER, DSS306-91-F-223Z	FM12223010	CP09			CER. 27 PF \pm 5%	DA15270110
L201					CP10			CER. 0.047 μ F +80%-20%	DA17473110
§		4822 158 60605	FERRITE CORE, BEADS (B-01-RT)	FC90050060	CP11		4822 124 41539	ELECT 47 μ F 16V	OA47601620
L204					CP15			CER. 0.047 μ F +80%-20%	DA17473110
L205		4822 242 73843	DSS306-91-F-223Z	FM12223010	CP16		4822 124 41539	ELECT 47 μ F 16V	OA47601620
L206		4822 242 73843	DSS306-91-F-223Z	FM12223010	CT02			CER. 4700 PF +80%-20%	DK18472310
					CT04			CER. 0.022 μ F +80%-20%	DK18223310
					C111				
					§			CER. 220 PF \pm 5%	DD15221300
					C116				
					C119			CER. 0.047 μ F +80%-20%	DA17473110
					C120		4822 124 41539	ELECT 47 μ F 16V	OA47601620

POS. NO.	VERS. COLOR	PART NO. (For EUROPE)	DESCRIPTION	PART NO. (For U/K/F)	POS. NO.	VERS. COLOR	PART NO. (For EUROPE)	DESCRIPTION	PART NO. (For U/K/F)	
C121			CER. 0.047 μ F +80%-20%	DA17473110	C***			PLASTIC FILM CAPACITOR ONE WAY TYPE, MYLAR \pm 5% 50V CT101, C131-C133, C139-C142, C149, C155, C156, C161, C506		
C122		4822 124 41539	ELECT 47 μ F 16V	OA47601620						
C123			CER. 0.047 μ F +80%-20%	DA17473110						
C124		4822 124 41534	ELECT 10 μ F 25V	OA10602520						
C134		4822 124 90357	ELECT 2.2 μ F 50V	OA22505020						
C135		4822 124 41539	ELECT 47 μ F 16V	OA47601620						
C136			CER. 0.022 μ F +80%-20%	DK18223310						
C137			CER. 0.022 μ F +80%-20%	DK18223310						
C138		4822 124 41539	ELECT 47 μ F 16V	OA47601620						
C143			CER. 150 PF \pm 10%	DA16151110						
C144			CER. 150 PF \pm 10%	DA16151110						
C146			CER. 0.022 μ F +80%-20%	DK18223310						
C148			CER. 0.022 μ F +80%-20%	DK18223310						
C151			CER. 0.022 μ F +80%-20%	DK18223310						
C152			CER. 0.022 μ F +80%-20%	DK18223310						
C153		4822 124 41539	ELECT 47 μ F 16V	OA47601620						
C154		4822 124 41539	ELECT 47 μ F 16V	OA47601620						
C501			CER. 150 PF \pm 10%	DA16151110						
C503			CER. 0.047 μ F +80%-20%	DA17473110						
C504		4822 124 90363	ELECT 220 μ F 10V	OA22701020						
C507			CER. 47 PF \pm 5%	DA15470110						
C508			CER. 0.022 μ F +80%-20%	DK18223310						
C509			CER. 0.047 μ F +80%-20%	DA17473110						
C510		4822 124 90363	ELECT 220 μ F 10V	OA22701020						
C511		4822 124 90363	ELECT 220 μ F 10V	OA22701020						
C512			CER. 0.047 μ F +80%-20%	DA17473110						
C513			CER. 0.047 μ F +80%-20%	DA17473110						
C514			CER. 47 PF \pm 5%	DA15470110						
C521			CER. 10 PF \pm 5%	DD11100300						
C522			CER. 39 PF \pm 5% [PMD320]	DD15390300						
C523			CER. 10 PF \pm 5% [PMD321]	DD11100300						
C523			CER. 0.01 μ F +80%-20%	DA17103110						
C601		4822 124 41539	ELECT 47 μ F 16V	OA47601620						
C602		4822 124 41539	ELECT 47 μ F 16V	OA47601620						
C603			CER. 47 PF \pm 5%	DA15470110						
C604			CER. 47 PF \pm 5%	DA15470110						
C611		4822 124 90354	ELECT 100 μ F 16V	OA10701620						
C612		4822 124 90354	ELECT 100 μ F 16V	OA10701620						
C651		4822 124 90364	ELECT 220 μ F 16V [PMD320]	OA22701620						
C652		4822 124 90364	ELECT 220 μ F 16V [PMD320]	OA22701620						
C653		4822 124 90364	ELECT 220 μ F 16V [PMD320]	OA22701620						
C654		4822 124 90364	ELECT 220 μ F 16V [PMD320]	OA22701620						
C655			CER. 100 PF \pm 10% [PMD320]	DA16101110						
C656			CER. 100 PF \pm 10% [PMD320]	DA16101110						
▲C803		4822 124 41538	ELECT 220 μ F 35V	OA22703520						
▲C804		4822 124 41538	ELECT 220 μ F 35V	OA22703520						
C805		4822 124 41539	ELECT 47 μ F 16V	OA47601620						
C806		4822 124 41539	ELECT 47 μ F 16V	OA47601620						
C811			CER. 0.047 μ F +80%-20%	DA17473110						
C812			CER. 0.047 μ F +80%-20%	DA17473110						
▲C813		4822 124 80582	ELECT 4700 μ F 16V	OA47801620						
▲C814		4822 124 22722	ELECT 1000 μ F 16V	OA10801620						
C815		4822 124 41539	ELECT 47 μ F 16V	OA47601620						
▲C852		4822 124 90355	ELECT 100 μ F 50V	OA10705020						
C853			ELECT 47 μ F 35V	OA47603520						
C854		4822 124 90355	ELECT 100 μ F 50V	OA10705020						
C901		4822 124 41534	ELECT 10 μ F 25V	OA10602520						
C902		4822 124 41534	ELECT 10 μ F 25V	OA10602520						
C903		4822 124 41539	ELECT 47 μ F 16V	OA47601620						
C904		4822 124 41539	ELECT 47 μ F 16V	OA47601620						
C905			CER. 100 PF \pm 10%	DA16101110						
C906			CER. 100 PF \pm 10%	DA16101110						
C***			P116-CAPACITORS (COMMON) CER. CAPACITOR DISC TYPE, TEMP. COEFF. P350-N1000, 50V: C502		R***			P116-RESISTORS (COMMON) CARBON FILM FIXED RESISTOR, \pm 5% 1/6W: RD11-RD13, RE01-RE05, RF02, RF03, RF06, RF08-RF17, RF20-RF23, RF51-RF57, RN01, RN02, RN04-RN07, RN09, RN10, RN15-RN18 [PMD320], RN23, RN26-RN31, RN91-RN94, RP02, RP05, RP07, RP08, RP51-RP57, RP59, RT01, RT02, R107, R114-R119, R121, R124-R126, R129-R135, R137-R148, R510, R514, R151-R163, R171, R501-R507, R509, R521, R522, R601-R606, R651-R658 [PMD320], R851-R855, R901-R904, R907-R919, R913, R914		
C***			HIGH DELECTRIC CONSTANT CER. CAPACITOR DISC TYPE, TEMP CHARA. 2B4 50V: CP18, CP51, CT03, C117, C118, C505							
▲DN01						DE01	4822 130 32362		DIODE, 1SS176,MA165,1SS254 30V 0.1A	HD20002000
▲DN04						DE02	4822 130 32362		DIODE, 1SS176,MA165,1SS254 30V 0.1A	HD20002000
DN05						DF01	4822 130 32362		DIODE, 1SS176,MA165,1SS254 30V 0.1A	HD20002000
DN06						DF03	4822 130 32362		DIODE, 1SS176,MA165,1SS254 30V 0.1A	HD20002000
DN07						DF04	4822 130 32362		DIODE, 1SS176,MA165,1SS254 30V 0.1A	HD20002000
DN23						DF51	4822 130 32362		DIODE, 1SS176,MA165,1SS254 30V 0.1A	HD20002000
DN24						DF52	4822 130 32362		DIODE, 1SS176,MA165,1SS254 30V 0.1A	HD20002000
D151						▲DN01	4822 130 80839		DIODE, S5688G VRM=400V IO=1A	HD20029050
D152						▲DN04	4822 130 32362		DIODE, 1SS176,MA165,1SS254 30V 0.1A	HD20002000
						DN05	4822 130 32362		DIODE, 1SS176,MA165,1SS254 30V 0.1A	HD20002000
						DN06	4822 130 33948		ZENER DIODE, 5.6V MTZJ5.6B	HD30561000
						DN07	4822 130 32362		DIODE, 1SS176,MA165,1SS254 30V 0.1A	HD20002000
						DN23	4822 130 32362		DIODE, 1SS176,MA165,1SS254 30V 0.1A	HD20002000
						DN24	4822 130 32362		DIODE, 1SS176,MA165,1SS254 30V 0.1A	HD20002000
						D151	4822 130 80839		DIODE, S5688G VRM=400V IO=1A	HD20029050
						D152	4822 130 80839		DIODE, S5688G VRM=400V IO=1A	HD20029050

POS. NO.	VERS. COLOR	PART NO. (For EUROPE)	DESCRIPTION	PART NO. (For U / K / F)	POS. NO.	VERS. COLOR	PART NO. (For EUROPE)	DESCRIPTION	PART NO. (For U / K / F)
▲D801		4822 130 80839	DIODE, S5688G VRM=400V IO=1A	HD20029050	JT02			TERMINAL, 1P RCA DIG. OUT	YT02010780
▲D804					JW07		4822 265 41351	JACK, ZC-015 15P [PMD321]	YJ07007960
▲D811		4822 130 80839	DIODE, S5688G VRM=400V IO=1A	HD20029050	J103		4822 265 41351	JACK, 15P	YJ07007960
▲D814					J601			TERMINAL, 2P RCA ANA. OUT [PMD320]	YT02021210
▲D851		4822 130 80839	DIODE, S5688G VRM=400V IO=1A	HD20029050	LT01		4822 142 60388	PULSE TRANSF.	TP41042010
▲D852		4822 130 80318	ZENER DIODE, 6.8V MTZJ6.8C	HD30681000	▲L001	U		POWER TRANSF.	TS15734030
D853		4822 130 33759	ZENER DIODE, 4.7V MTZJ4.7B	HD30471000	▲L001	/02	4822 146 21749	POWER TRANSF.	TS15734010
▲D854	/02	4822 130 80839	DIODE, S5688G VRM=400V IO=1A	HD20029050	▲SH91		4822 276 13364	PUSH SW, POWER SW	SP01011990
▲D855	U	4822 130 80839	DIODE, S5688G VRM=400V IO=1A	HD20029050	XF01		4822 242 72066	CER. VIB., 8.0MHZ	FQ08004010
QD01		4822 209 33252	IC, DAC TDA1549/N1	HC10130490	XP01		4822 242 72334	X'TAL 16.9344MHZ	JX16002260
QE01		4822 130 42298	TRS. 2SC536SP, 2SC2458, 2SC3311, 2SC1740S	HT30001000	X101		4822 242 81536	CER. VIB. 8.46MTW	FQ08464010
QF01			MAIN CPU MN187164	HU313KA000	P126-HF CIRCUIT BOARD				
QF02		4822 209 73951	IC, RESET IC PST523D	HC10010550	P126-CAPACITORS				
QF51		4822 130 42715	TRS. 2SA608SP, 2SA1048, 2SA1309, 2SA933	HT10001000	C101			CER. 100 PF ± 10%	DA16101110
QF52		4822 130 42298	TRS. 2SC536SP, 2SC2458, 2SC3311, 2SC1740S	HT30001000	C102			CER. 47 PF ± 5%	DA15470110
QM01		4822 209 72587	IC, DUAL POWER OP AMP TCA0372	HC10034170	C103			CER. 47 PF ± 5%	DA15470110
QN01					C104			CER. 18 PF ± 5%	DA15180120
QN04		4822 130 42298	TRS. 2SC536SP, 2SC2458, 2SC3311, 2SC1740S	HT30001000	C105		4822 124 41534	CER. 150 PF ± 10%	DA16151110
QN05					C106			ELECT 10 µF 25V	OA10602520
QN08		4822 130 43818	TRS. 2SC2878 (A OR BRANK) [PMD320]	HT328782A0	C107			CER. 0.047 µF +80%-20%	DA17473110
QN20		4822 130 42298	TRS. 2SC536SP, 2SC2458, 2SC3311, 2SC1740S	HT30001000	C108			CER. 150 PF ± 10%	DA16151110
QN24		4822 130 42715	TRS. 2SA608SP, 2SA1048, 2SA1309, 2SA933S	HT10001000	C109			CER. 150 PF ± 10%	DA16151110
QN25		4822 130 42715	TRS. 2SA608SP, 2SA1048, 2SA1309, 2SA933S	HT10001000	C110			CER. 330 PF ± 10%	DA16331110
QN91					P126-RESISTORS (COMMON)				
QN94		4822 130 43818	TRS. 2SC2878 (A OR BRANK)	HT328782A0	CARBON FILM FIXED RESISTOR, ± 5% 1/6W: R101-R106				
QP01			IC, PF-G-BND MB87014A -TF	HC10103180	Q101		4822 130 61748	TRS. 2SC2668-0	HT32668100
QP02			IC, SN74LS628NS	HC762837Z0	Q102		4822 130 42298	TRS. 2SC536SP, 2SC2458, 2SC3311, 2SC1740S	HT30001000
QP03		4822 209 30426	IC, 74HC00	HC700000Z0	Q103		4822 130 42715	TRS. 2SA608SP, 2SA1048, 2SA1309, 2SA933S	HT10001000
Q104		4822 209 32763	IC, DIG. SERVO TDA1301T	HC10106490	P126-MISCELLANEOUS				
Q105		4822 209 72587	IC, DUAL POWER OP AMP CA0372	HC10034170	J101		4822 265 41349	JACK, TOC-L12X-A1 12P	YJ07007950
Q106		4822 209 72587	IC, DUAL POWER OP AMP TCA0372	HC10034170	J102		4822 265 41351	JACK, ZC-015 15P	YJ07007960
Q501		4822 130 42298	TRS. 2SC536SP, 2SC2458, 2SC3311, 2SC1740S	HT30001000	P136-H.P CIRCUIT BOARD				
Q502		4822 130 42298	TRS. 2SC536SP, 2SC2458, 2SC3311, 2SC1740S	HT30001000	P136-CAPACITOR				
Q503		4822 209 33339	IC, CD DECODER SAA7345GP/M5X	HC10128490	C980			CER. 0.022 µF +80%-20%	DK18223310
Q601		4822 209 83274	IC, NJM4560D	HC10007090	P136-MISCELLANEOUS				
▲Q801		4822 209 31712	IC, NJM78M12FA	HC38512090	J900		4822 267 31691	JACK, HEAD PHONE	YJ01003870
▲Q802		4822 209 63641	IC, NJM79M12FA	HC39512090					
▲Q811		4822 209 31631	IC, NJM7805FA	HC38905090					
▲Q851		4822 209 83829	IC, REG. NJM79M18FA	HC39518090					
Q852		4822 130 42298	TRS. 2SC536SP, 2SC2458, 2SC3311, 2SC1740S	HT30001000					
Q853		4822 130 42715	TRS. 2SA608SP, 2SA1048, 2SA1309, 2SA933S	HT10001000					
Q854		4822 130 42715	TRS. 2SA608SP, 2SA1048, 2SA1309, 2SA933S	HT10001000					
Q901		4822 209 82362	IC, NJM4556D	HC10016090					
P116-MISCELLANEOUS									
▲FH11	U		FUSE, 1.6A 125V FBM	FS10160360					
▲FH11	/02	4822 070 36301	FUSE, 630MA 250V BS LISTED	FS10063850					
▲FH12	U		FUSE, 1.6A 125V FBM	FS10160360					
▲FH12	/02	4822 070 36301	FUSE, 630MA 250V BS LISTED	FS10063850					
JE01		4822 267 31691	JACK, FADER	YJ01003870					
JF01			JACK, 37 PIN FFC	YJ06011070					
JF03		4822 267 41009	TERMINAL, 2P RCA (RC-5 IN/OUT)	YT02020890					
JM01		4822 265 30473	PLUG, 6P	YP06003420					
JM02		4822 265 30482	PLUG, 4P	YP06003440					